

SV2000

Video
Cassette
Recorder

Owner's Manual

IMPORTANT!
Return Your Warranty Registration Card
Within 10 Days. See Why Inside.

MODEL SVZ142

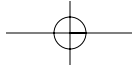

Return your Warranty Registration Card today to ensure you receive all the benefits you're entitled to.

Once your purchase is registered, you're eligible to receive all the privileges of owning this product. So complete and return the Warranty Registration Card enclosed with your purchase at once. And take advantage of these important benefits.

Warranty Verification

Registering your product within 10 days confirms your right to maximum protection under the terms and conditions of your warranty.

Owner Confirmation

Your completed Warranty Registration Card serves as verification of ownership in the event of product theft or loss.

Model Registration

Returning your Warranty Registration Card right away guarantees you'll receive all the information and special offers which you qualify for as the owner of your model.

SV2000

Congratulations on your purchase, and welcome to the "family!"



Dear product owner:

Thank you for your confidence in this product. You've selected one of the best-built, best-backed products available today. And we'll do everything in our power to keep you happy with your purchase for many years to come.

As a member of the SV2000 "family," you're entitled to protection by one of the most comprehensive warranties and outstanding service networks in the industry.

What's more, your purchase guarantees you'll receive all the information and special offers for which you qualify, plus easy access to accessories from our convenient home shopping network.

And most importantly, you can count on our uncompromising commitment to your total satisfaction.

All of this is our way of saying welcome - and thanks for investing in an SV2000 product.

P.S. Remember, to get the most from your product, you must return your Warranty Registration Card within 10 days. So please mail it to us right now!

Know these

safety symbols



⚡ This "bolt of lightning" indicates uninsulated material within your unit may cause an electrical shock. For the safety of everyone in your household, please do not remove product covering.

⚠ The "exclamation point" calls attention to features for which you should read the enclosed literature closely to prevent operating and maintenance problems.

WARNING: TO PREVENT FIRE OR SHOCK HAZARD, DO NOT EXPOSE THIS EQUIPMENT TO RAIN OR MOISTURE.

CAUTION: To prevent electric shock, match wide blade of plug to wide slot, and fully insert.

ATTENTION: Pour éviter les chocs électriques, introduire la lame la plus large de la fiche dans la borne correspondante de la prise et pousser jusqu'au fond.

For Customer Use

Below, enter your product's model number and serial number, which are located on the rear of the cabinet. Keep this information for future reference.

Model No. _____ Serial No. _____

Introduction 3

.....
Welcome to your VCR owner's manual.

This manual has six sections: Setting Up Your VCR; Description of Controls; Basic Operations; Recording; Playing; and Information You May Need. The instructions explain all of the VCR's features, which are listed below. You cannot hurt your VCR by trying the features!

So read on – and relax.

Features

- Auto Return
- Auto Satellite Link
- Automatic Channel Setup
- Automatic Playback Features
- Automatic Tracking Adjustment
- Display Panel
- High Quality (HQ) System
- On-Screen Displays in English or Spanish
- One-Touch Recording
- Real-Time Counter
- Remote Control
- Rental Play
- Repeat Play
- Special Effects Playback: Forward and Reverse Searching; Still; Slow
- Special Search Functions: Index; Time; Quick Find
- Timer Recording

Safety Precautions

Warning: To prevent fire or shock hazard, do not expose this equipment to rain or moisture.

FCC Warning: Any unauthorized changes or modifications to this equipment void the user's authority to operate it.

This VCR, equipped with a High Quality (HQ) system, is compatible with existing Video Home System (VHS) equipment. Philips Consumer Electronics Company recommends that you use only video cassette tapes that have been tested and inspected for use in two, four, six, and eight hour VCRs, and which are labeled with the **VHS** mark. The use of tapes that have not been inspected for use in two, four, six, and eight hour VCRs may result in poor picture quality and excessive deposits on the video heads, which may not be covered by the warranty if damage occurs.

Note to the Cable TV System Installer: This reminder is provided to call the Cable TV system installer's attention to Article 820-40 of the National Electrical Code, which provides guidelines for proper grounding – in particular, specifying that the cable ground shall be connected to the grounding system of the building, as close to the point of cable entry as possible.

Copyright 1998 Philips Consumer Electronics Company. All rights reserved.

Helpful Hint

- Before doing anything else, record the VCR's model and serial numbers in the spaces provided on page two. These numbers will help us assist you if you ever call for help.

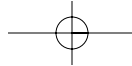

4 Table of Contents

Setting Up Your VCR

Introduction	3
Table of Contents	4
Before Using Your VCR	5
Hookups Without a Cable Box/Direct Broadcast System	6 - 7
Hookups With a Cable Box/Direct Broadcast System	8 - 9
Hookups With a Stereo TV	10
Turning on Your VCR	11
Automatic Channel Setup	12 - 13
Setting the Clock	14 - 15
Language Selection	16

Description of Controls

On-Screen Status Displays	17
Remote Control Buttons	18 - 19
VCR Display Panel	20
Front Panel	21
Rear Panel	22

Basic Operations

Playing	23
Recording	24

Recording

One-Touch Recording	25
Timer Recording	26 - 29
Auto Return	30
Auto Satellite Link Using a Satellite Tuner	31
Recording One Channel/Watching Another	32
Rerecording (Tape Duplication)	33

Playing

Repeat Play	34
Special Effects Playback	35
Rental Play	36
Real-Time Counter Memory	37
Index Search	38
Time Search	39
Quick Find	40
Automatic Playback Features	41

Information You May Need

Helpful Hints	42 - 43
Glossary	44
Specifications	45
Limited Warranty	46
Index	47
Supplied Accessories	48

Before Using Your VCR 5

Putting Batteries in the Remote Control

1

Remove the battery compartment lid on the bottom of the remote control by sliding the lid in the direction of the arrow.

2

Insert two AA batteries inside the battery compartment with their + and - ends aligned as indicated.

3

Replace the battery compartment lid.

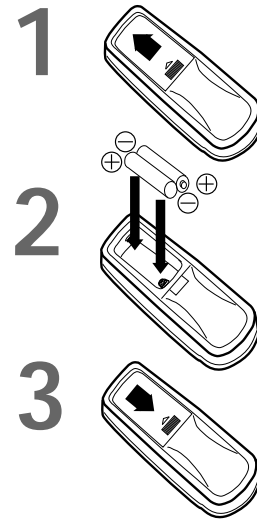

Using the Remote Control

- Point the remote control at the VCR's remote sensor (see page 21) when using the remote control to operate the VCR.
- Do not put objects between the remote control and the VCR.

Erase Prevention

Video cassette tapes have record tabs to ensure that recordings are not erased accidentally.

1

To prevent accidental erasure, break off the tab with a screwdriver.

2

To record again, cover the hole with cellophane tape.

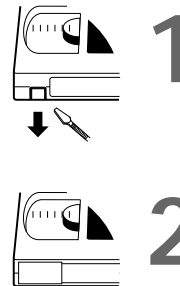

VCR maintenance

- In this VCR, use only tapes with the **VHS** mark.
- Make sure any light adhesive stick-on notes are removed from the video cassette tape before putting the tape in the VCR. Removable labels like these can jam the VCR.
- Periodic maintenance is required to maintain your VCR's performance. The video heads will eventually require cleaning or replacement. Cleaning or replacement of the video heads should be performed by an authorized service center.

Helpful Hints

- The remote control and its batteries are supplied.
- Do not mix alkaline and manganese batteries.
- Do not mix old and new batteries.

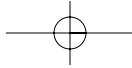

6 Hookups Without a Cable Box/Direct Broadcast System

The basic VCR/TV connection – antenna/cable to VCR to TV – is shown below. If you have a Cable Box or Direct Broadcast System, please refer to pages eight - nine. If you have a Stereo TV, please go to page 10. After you hook up the VCR, please go to page 11 to turn on the VCR.

1

Disconnect the antenna or cable from your TV.

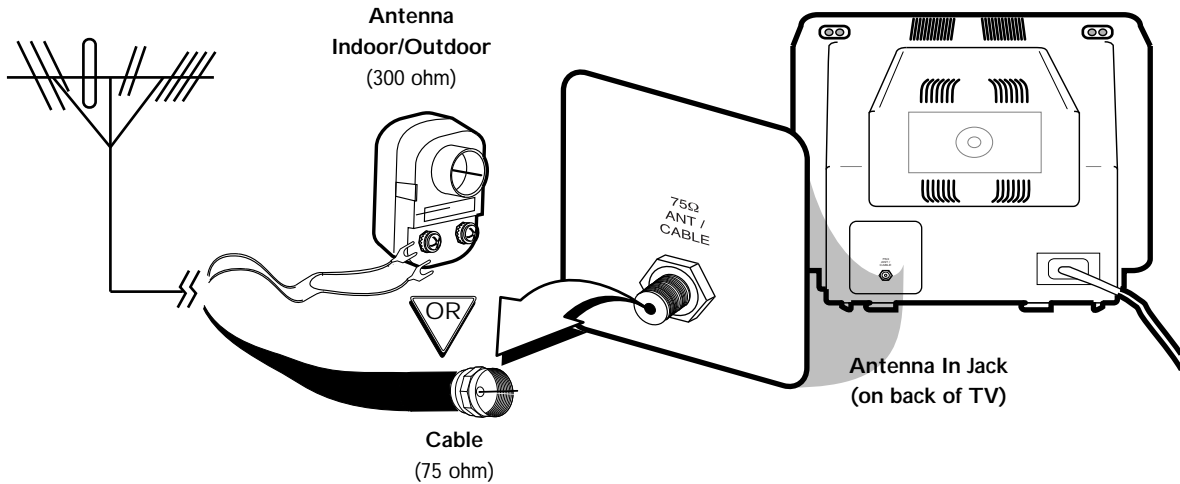

2

Connect the antenna or cable to the ANT(enna) IN jack of your VCR.

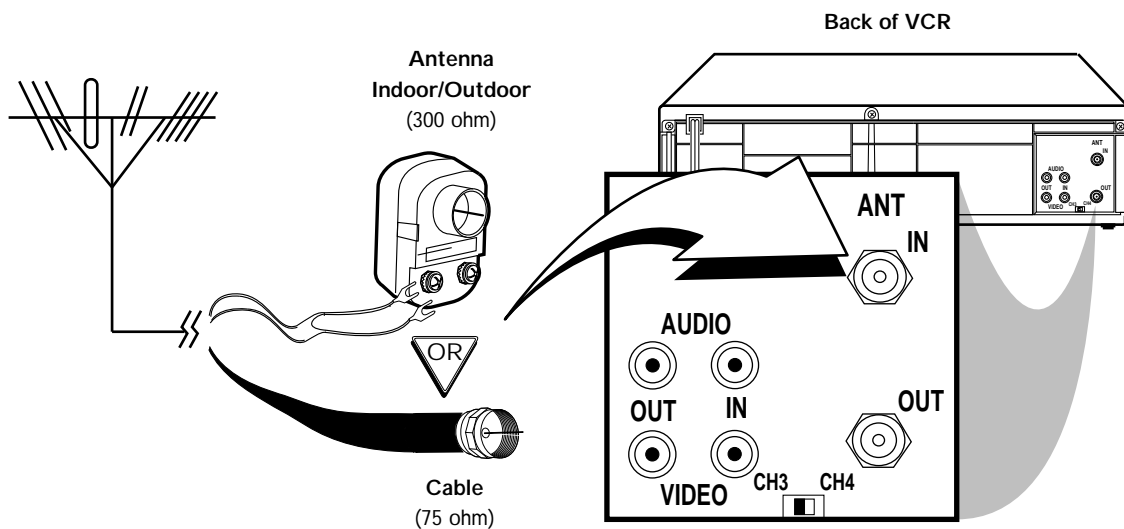

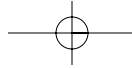

Hookups Without a Cable Box/Direct Broadcast System (cont'd) 7

3

Connect the RF coaxial cable (supplied) to the **OUT** jack on the back of the VCR and to the **ANTENNA IN** Jack on the TV. (You may use either a snap-on type or screw-on type of coaxial cable, whichever you prefer. A snap-on type is supplied.)

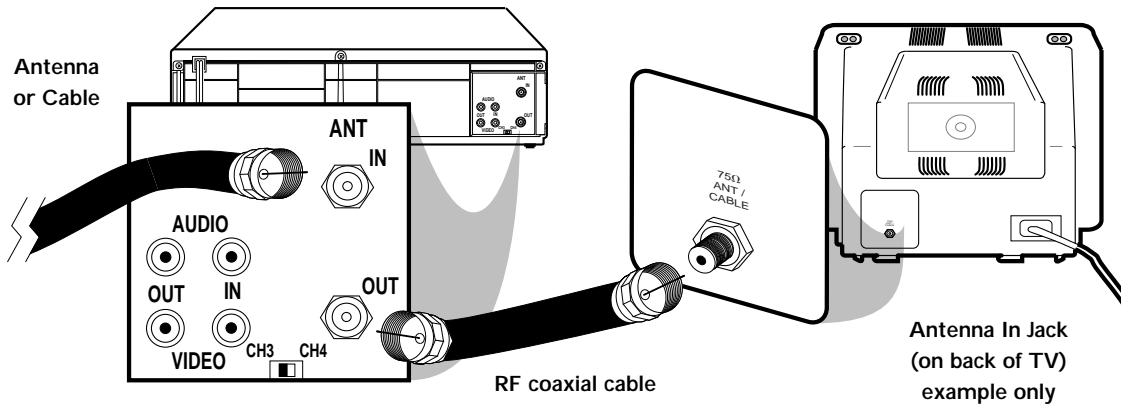

4

Plug in the TV and the VCR.

5

Set the **CH3/CH4** switch on the back of the VCR to **CH3** or **CH4**, whichever channel is not used or least used in your area. To operate your VCR with your TV, **set the TV to the same channel**. For example, when playing a tape, if the CH3/CH4 switch is set to CH3, the TV should be on channel 3.

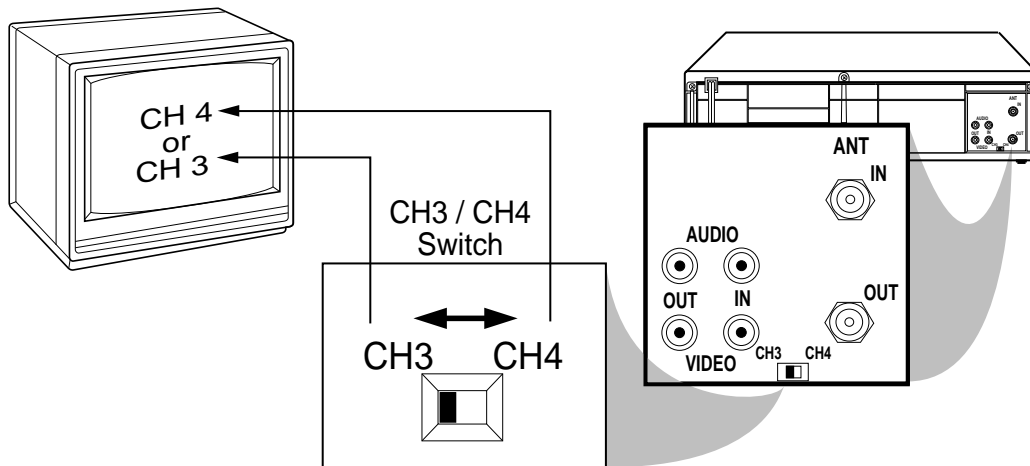

6

You are ready to turn on the VCR. Please go to page 11 before turning on the VCR.

8 Hookups With a Cable Box

This connection allows you to view any channel. After you connect the Cable Box, VCR, and TV as shown below, the features described on this page will be available.

1. Connect a Cable signal to the IN Jack on the Cable Box.

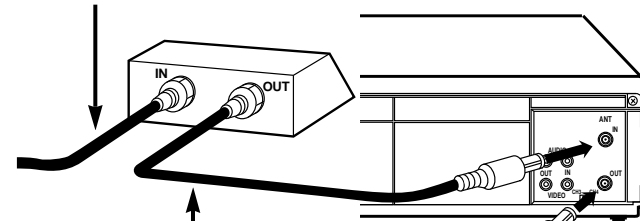

2. Use an RF coaxial cable (supplied) to connect the OUT Jack on the Cable Box to the ANT(enna) IN Jack on the VCR.

3. Use a second RF coaxial cable to connect the OUT jack on the VCR to the TV's ANTENNA IN Jack.

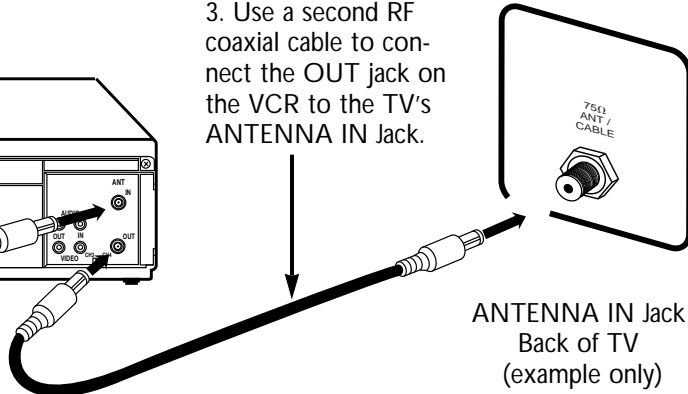

ANTENNA IN Jack
Back of TV
(example only)

Recording and Viewing a Scrambled or Unscrambled Channel

1

With the VCR on and in VCR position (the VCR/TV light will appear), use the **CHANNEL (Up/Down) buttons** to set the VCR to the Cable Box output channel (channel 03 or 04).

2

Set the TV to the same channel to which you set the VCR.

3

Select the channel you want to watch or record at the Cable Box.

**CHANGED
INSERT NEW
PAGE**

Watching TV With the VCR Off

Use the TV channel selector to set the TV to the Cable Box output channel (channel 03 or 04). Then, select the channel you want to watch at the Cable Box.

Timer Recordings

With this connection, you may set a timer recording as described on pages 26 - 29. However, remember the following:

- You can only program a timer recording for one channel at a time.
- Set the TV and the VCR to the Cable Box output channel (channel 03 or 04).
- When you enter the channel you want to record, select channel 03 or 04 (the Cable Box output channel). (This is step 7 on page 28.)
- Set your Cable Box to the channel you want to record.
- Leave the Cable Box on while you are recording.

Helpful Hints

- With this hookup, channels cannot be changed using the VCR remote control. You must select channels at the Cable Box.
- You can not view a channel other than the one you are recording (the instructions on page 32 do not work with this hookup).
- You cannot program channels with this hookup (as discussed on page 12).

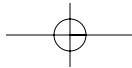

Hookups With a Cable Box (cont'd) 9

.....
 This connection allows you to program an unattended recording of more than one unscrambled channel and to watch one channel while recording another. After you connect the VCR, Cable Box, and TV as shown below, the features on this page will be available.

1. Connect a Cable signal to the VCR's ANT(enna) IN Jack.

2. Use an RF coaxial cable (supplied) to connect the OUT Jack on the VCR to the IN Jack on the Cable Box.

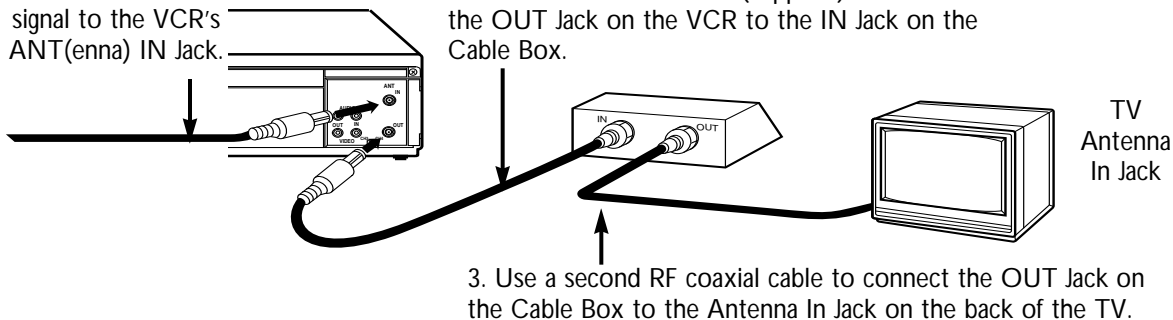

Recording One Channel/Watching Another

1

With the VCR on and in VCR position (the VCR/TV light will appear), use the **CHANNEL (Up/Down) buttons** to select the channel you want to record. Start the recording.

2

Press the **VCR/TV** button to put the VCR in TV position.

3

Use the TV channel selector to **put the TV on the Cable Box output channel (channel 03 or 04)**.

4

Select the channel you want to watch at the Cable Box.

Playing a Tape

1

Press the **VCR/TV** button to put the VCR in VCR position (the VCR/TV light will appear).

2

Make sure the Cable Box is on the same channel as the VCR's **CH3/CH4** switch.

3

Use the TV channel selector to **put the TV on the Cable Box output channel (channel 03 or 04)**.

4

Press the **PLAY** button to play the tape.

**CHANGED
 INSERT NEW
 PAGE**

Helpful Hint

- You cannot record scrambled channels with this connection.

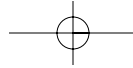

10 Hookups With a Stereo TV

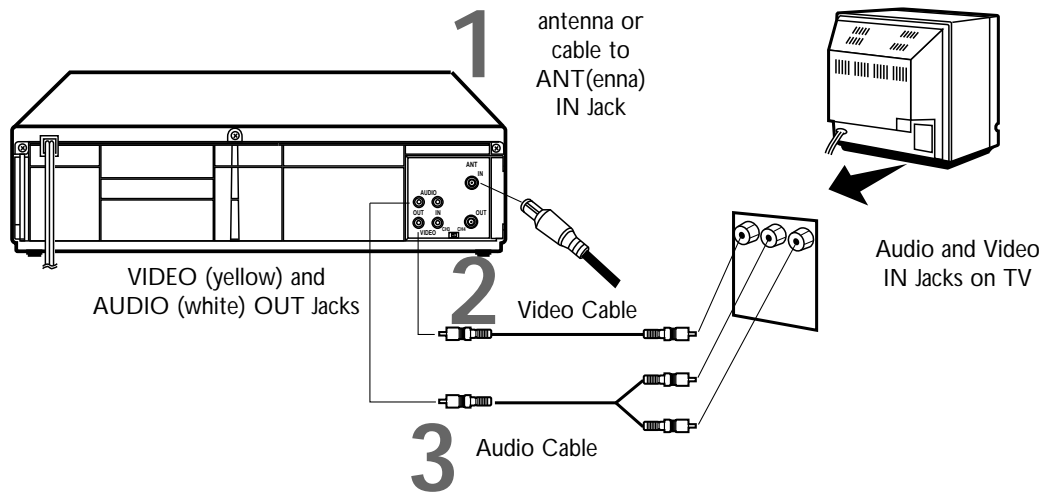

- Audio and Video cables are not supplied.

1

Connect the antenna or cable to the ANT(enna) IN Jack on the back of the VCR.

2

Connect a video cable to the yellow VIDEO OUT Jack on the back of the VCR. Then, connect the other end of the video cable to the VIDEO IN Jack on your TV.

3

Connect an audio cable to the white AUDIO OUT Jack on the back of the VCR. Then, connect the other end of the audio cable to the AUDIO IN Jack on your TV. (If your TV has Right and Left AUDIO IN Jacks, you must use a "Y" splitter audio cable as illustrated to deliver audio to the TV's left and right channels.)

4

Turn on your TV, making sure it is in Line Input mode. Please refer to your TV owner's manual for details.

Helpful Hint

- This hookup will not give you stereo sound. To get stereo sound, use the connections on pages six - seven and select the channel to be viewed at the TV (with the VCR turned off).

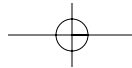

Turning on Your VCR 11

- Before turning on your VCR, make sure there are batteries in the remote control and the VCR and TV are connected (see pages five - 10).
- You can not set up channels if you are using a Cable Box/DBS.
- The instructions on this page only work when you turn on the VCR for the first time. If there is a power failure or if the VCR is unplugged for more than one minute, you may need to repeat the instructions on this page.

1

Press the **POWER** button. The POWER light and the VCR/TV light will appear.

2

Turn on the TV. Set it to the same channel as the **CH3/CH4** switch on the back of the VCR. The menu shown below will appear.

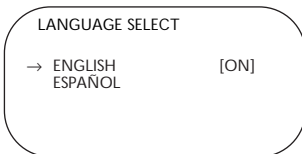

3

Press the **PLAY** button or the **STOP** button to select **ENGLISH** or **ESPAÑOL**. [ON] will appear beside your choice.

4

Press the **F.FWD** button or the **MENU** button. TUNER SET UP will appear on-screen.

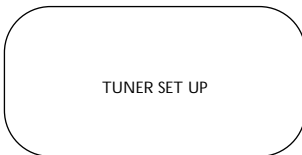

5

Press the **MENU** button, the **F.FWD** button, or the **REWIND** button to begin automatic channel setup.

TUNER SET UP will flash on-screen. The VCR will memorize all available channels, so when you use the **CHANNEL** ▲/▼ buttons, you'll only scan through channels that you receive. When channels are set up, the TV will go to the lowest channel available. (If you try to set up channels when there is no antenna or cable connected to the VCR, programming will appear to take place. Eventually, TUNER SET UP will appear on-screen steadily, and channel programming will stop. Connect an antenna or cable to the VCR, then press the **MENU** button, the **F.FWD** button, or the **REWIND** button again. Channel programming will begin again.)

2

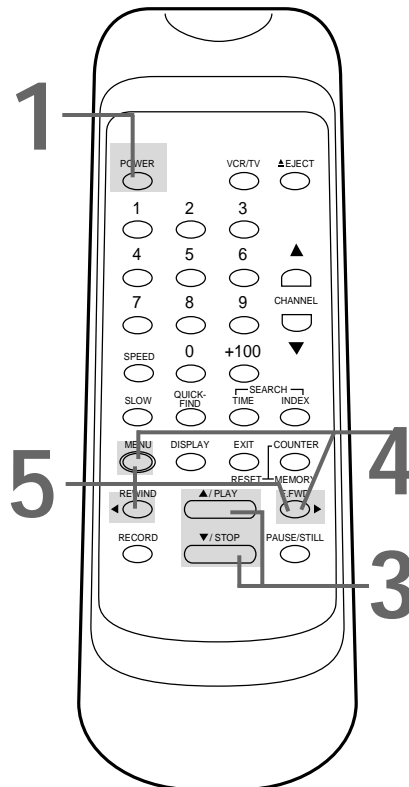
 Turn on the TV.

Helpful Hints

- If you do not see any on-screen displays when you turn on the VCR, check your hookups, then try again. If you still do not see any on-screen displays, follow the steps under "Automatic Channel Setup" on page 12 and "Language Selection" on page 16.

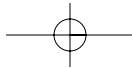

12 Automatic Channel Setup

Although your VCR may automatically set up the channels you receive when you turn it on for the first time, this function lets you set up channels again. Make sure:

- The VCR is on and is in VCR position. (The VCR/TV light will appear on the display panel. If it does not, press the VCR/TV button once.)

1

Press the **MENU** button repeatedly until the **INITIALIZE** menu appears.

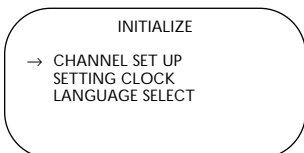

2

Press the **PLAY** button or the **STOP** button repeatedly to select **CHANNEL SET UP**. Then, press the **F.FWD** button.

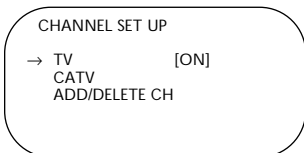

3

Press the **PLAY** button or the **STOP** button repeatedly to point to **TV** (if you have an antenna) or **CATV** (if you have a cable connection).

4

Press the **F.FWD** button once or twice. **[ON]** will appear beside your selection, then the VCR will memorize all available channels. When setup is complete, the lowest channel you receive will appear on-screen.

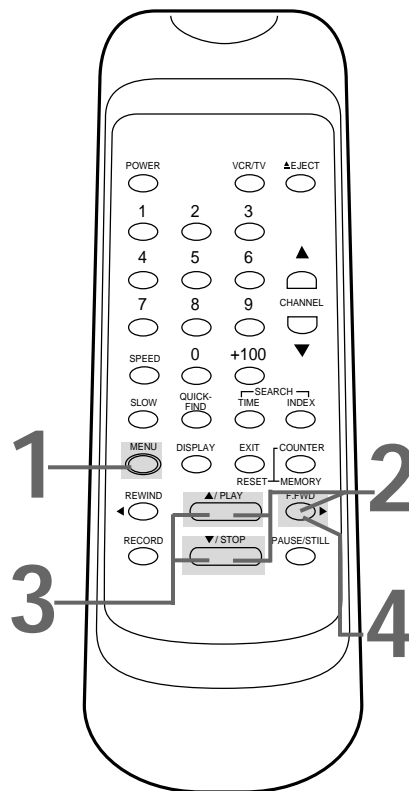

Helpful Hints

- Line Input mode will always be stored in the VCR's memory as channel 00. When you select channel 00 with the CHANNEL ▲/▼ buttons or the Number buttons, AUX will appear on-screen.
- You can not program channels if you are using a Cable Box/DBS. Details are on pages eight - nine.

Automatic Channel Setup (cont'd) 13

Adding/Deleting Channels

The channels you no longer receive or seldom watch can be deleted from the memory. You also may add new channels into the memory. Make sure:

- The VCR is on and in VCR position. (The VCR/TV light will appear. If it does not, press the VCR/TV button once.)

1

Press the **MENU** button repeatedly until the **INITIALIZE** menu appears.

2

Press the **PLAY** button or the **STOP** button repeatedly to select **CHANNEL SET UP**. Then, press the **F.FWD** button.

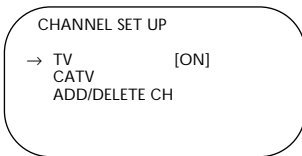

3

Press the **PLAY** button or the **STOP** button repeatedly to select **ADD/DELETE CH**. Then, press the **F.FWD** button.

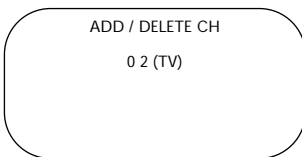

4

Press the **Number** buttons, the **PLAY** button, or the **STOP** button repeatedly until your desired channel number appears.

5

Press the **F.FWD** button or the **REWIND** button so that **ADD** or **DELETE** flashes on-screen.

6

While your choice is flashing, press the **COUNTER RESET/EXIT** button. The channel you added or deleted will appear. The channel will be added or deleted, whichever was flashing on-screen when you exited the menu.

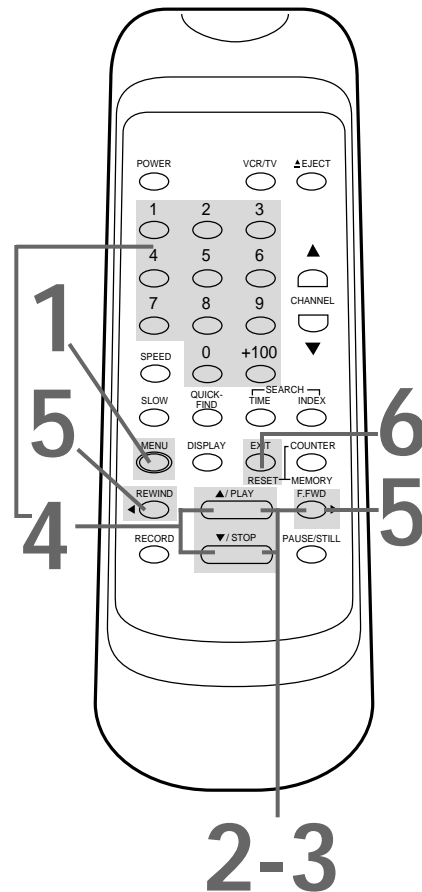

14 Setting the Clock

Follow the steps below to set your VCR's clock. Make sure:

- The VCR is on and in VCR position. (The VCR/TV light will appear. If it does not, press the VCR/TV button once.)

1

Press the **MENU** button repeatedly until the **INITIALIZE** menu appears.

2

Press the **PLAY** button or the **STOP** button repeatedly to select **SETTING CLOCK**. Then, press the **F.FWD** button.

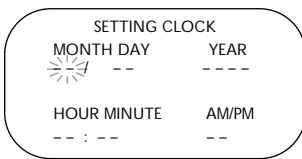

3

While the **MONTH** space is flashing, press the **PLAY** button or the **STOP** button repeatedly until the desired month appears. Then, press the **F.FWD** button.



4

While the **DAY** space is flashing, press the **PLAY** button or the **STOP** button repeatedly until the desired day appears. Then, press the **F.FWD** button.

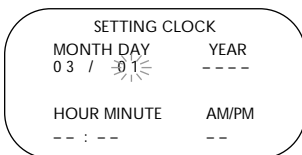

5

While the **YEAR** space is flashing, press the **PLAY** button or the **STOP** button repeatedly until the desired year appears. Press the **F.FWD** button. The day of the week will appear automatically.

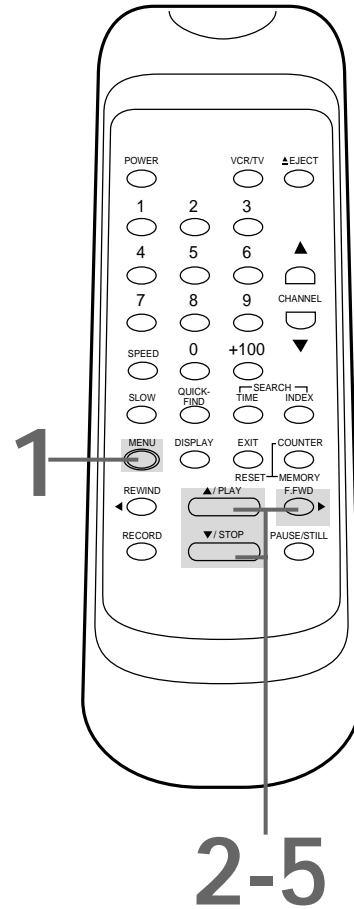
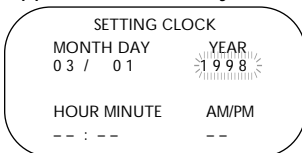

Helpful Hints

- To reset the clock, follow steps 1 - 2 above. Select the information you want to change using the **F.FWD** button or the **REWIND** button. When the desired information is flashing, use the **PLAY** button or the **STOP** button to enter the correct information. Press the **COUNTER RESET/EXIT** button to exit.
- To display the time, press the **DISPLAY** button repeatedly until the time appears on-screen.
- Power failures that last for more than one minute can cause you to lose your clock setting.
- Press the **REWIND** button to go back one step from the current step during steps 4 - 8.

Setting the Clock (cont'd) 15

6

While the HOUR space is flashing, press the PLAY button or the STOP button repeatedly until the desired hour appears. Then, press the F.FWD button.

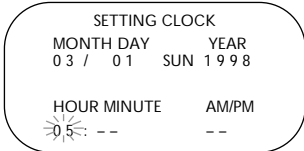

7

While the MINUTE space is flashing, press the PLAY button or the STOP button repeatedly until the desired minute appears. Then, press the F.FWD button.

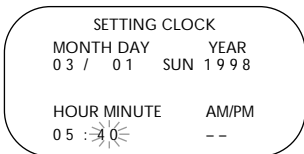

8

While the AM or PM space is flashing, press the PLAY button or the STOP button repeatedly to point to AM or PM.

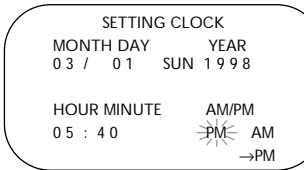

9

Press the COUNTER RESET/EXIT button or the F.FWD button to start the clock.

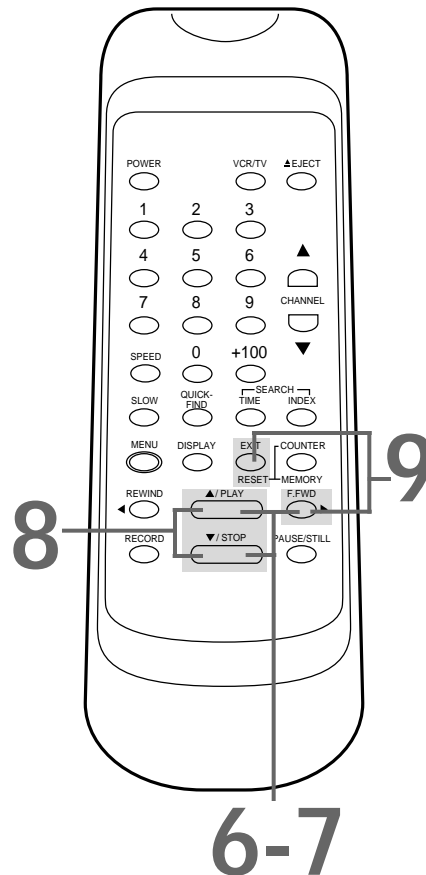

Helpful Hint

- If the clock has never been set, the SETTING CLOCK menu may appear immediately when you press the MENU button. If this happens, follow the instructions from step 3 on page 14.

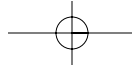

16 Language Selection

Follow the steps below to change the language of the on-screen menus and displays. Make sure:

- The VCR is on and in VCR position. (The VCR/TV light will appear. If it does not, press the VCR/TV button once.)

1

Press the **MENU** button repeatedly until the **INITIALIZE** menu appears.

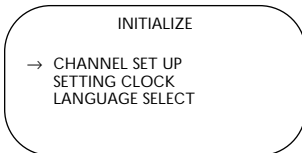

2

Press the **PLAY** button or the **STOP** button repeatedly to select **LANGUAGE SELECT**. Then, press the **F.FWD** button.

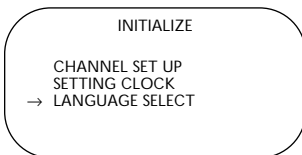

3

Press the **PLAY** button or the **STOP** button to select **ENGLISH** or **ESPAÑOL**. [ON] will appear beside your choice.

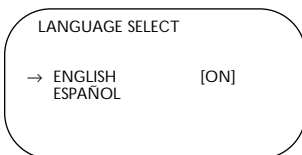

4

Press the **COUNTER RESET/EXIT** button to exit.

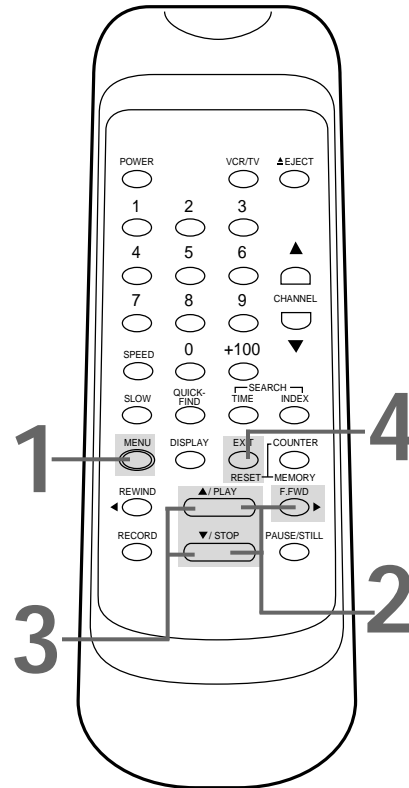

Helpful Hint

- If you accidentally select Spanish on-screen displays and need English on-screen displays:
 - 1) Press the **MENU** button repeatedly until the **PARA INICIAR** menu appears.
 - 2) Press the **PLAY** button or the **STOP** button repeatedly to choose **SELEC. IDIOMA**, then press the **F.FWD** button.
 - 3) Press the **PLAY** button or the **STOP** button to select **ENGLISH**.
 - 4) Press the **COUNTER RESET/EXIT** button to exit.

On-Screen Status Displays 17

You may access on-screen status displays by pressing the DISPLAY button repeatedly. On-screen status displays may include the current time, channel, and other information.

- Press the DISPLAY button once. The COUNT on-screen status display will appear for five seconds. After five seconds, only the real-time counter will appear on-screen. This counter shows you the elapsed playing time of the tape (from the point at which the real-time counter was set to zero).
- Press the DISPLAY button once again. The CLOCK on-screen status display will appear for five seconds. After five seconds, only the current time will appear on-screen (the clock must be set). (If you are watching TV, the current channel number will also appear on-screen.)
- Press the DISPLAY button once again. The on-screen status display will disappear.

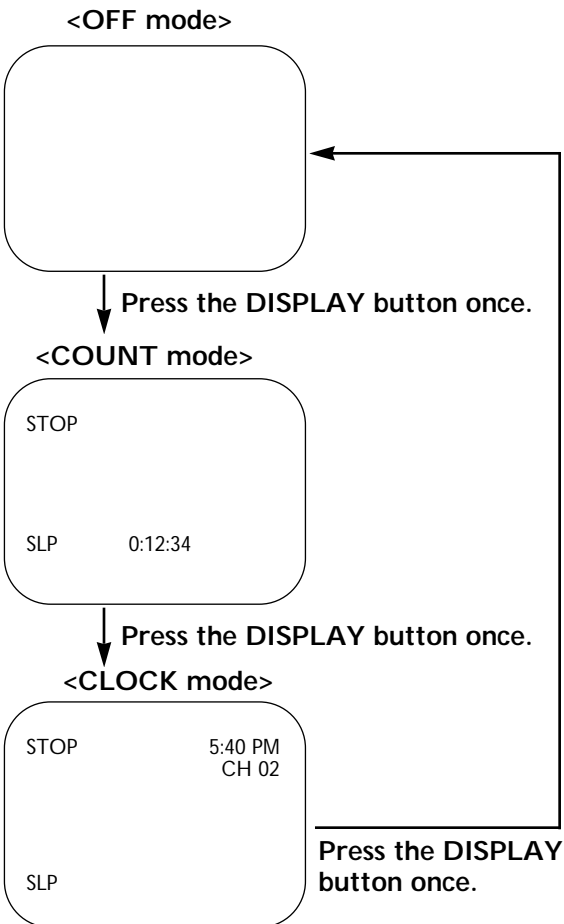

Helpful Hints

- If the channel you select has no broadcast, the screen will be solid blue.
- You may bring up a status display at any time by pressing the DISPLAY button. (The exception is when viewing a still picture or a slow motion picture, or when F.FWD or REWIND is pressed during playback.)
- Channel numbers (when tuned) appear on-screen for a few seconds.

Remote Control Buttons (cont'd) 19

- EJECT Button**
Press to eject the tape.
- VCR/TV Button**
Use to select the signal that your TV receives.
- **VCR Position**
Use to watch a tape, to watch a program while recording it, or to watch a TV broadcast using the CHANNEL ▲/▼ or Number buttons.
 - **TV Position**
Use to watch TV or to watch one program while recording another. *Details are on page 32.*
- CHANNEL ▲/▼ Buttons**
Press to scan up or down through the VCR's channels after the channels have been set up. *Details are on page 12.*
During slow motion playback, press to adjust the tracking. *Details are on page 41.*
- TIME SEARCH Button**
Press to perform a Time Search. *Details are on page 39.*
- INDEX SEARCH Button**
Press to perform an Index Search. *Details are on page 38.*
- COUNTER MEMORY Button**
Press to memorize a tape position at which the real-time counter was set to 0:00:00. *Details are on page 37.*
- COUNTER RESET/EXIT Button**
Press to set the real-time counter to zero. *Details are on page 37.*
Press to remove menus.
- STOP Button**
Press to stop the tape.
Use to enter digits and information when programming a function in the on-screen menu (setting the clock, for example). Press to select an item in the on-screen menu.
- PAUSE/STILL Button**
During recording, press to temporarily stop the recording. *Details are on page 24.* You can not pause a One-Touch Recording. *Details are on page 25.* During tape playback, press to freeze the picture. Press the PAUSE/STILL button repeatedly to advance the picture frame by frame. *Details are on page 35.*
- F.FWD Button**
When tape playback is stopped, press to fast forward the tape at high speed. During tape playback, press to fast forward the tape while the picture stays on-screen. *Details are on page 35.* Press to add or delete channel numbers. *Details are on page 13.*

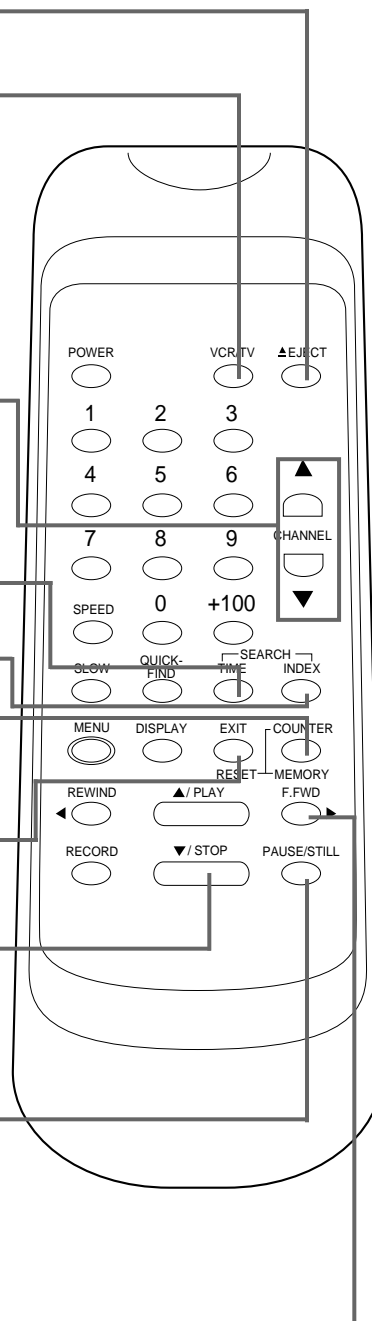

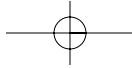

20 VCR Display Panel

Cassette Compartment
Insert a video cassette tape here.

VCR Display Panel
Information about VCR operations is displayed here.

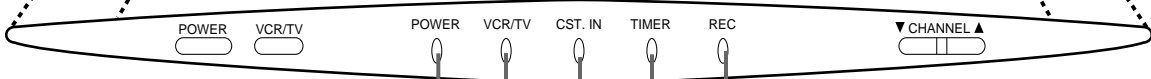
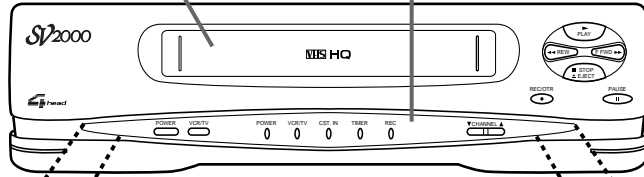

POWER Light
This light indicates that the power is on.

VCR/TV Light
This light appears when the VCR is in VCR position.

REC(ord) Light
This light appears during a recording. It flashes when a recording is paused.

TIMER Light
This light glows when you turn off the power to set a timer recording. It also glows during a One-Touch Recording. It flashes when you turn off the power to set a timer recording if a tape has not been placed in the VCR. It flashes when all timer recordings have finished.

CST.IN Light
This light appears when a tape is in the VCR.

Front Panel 21

Remote Sensor

Receives a signal from your remote control so you can operate your VCR from a distance.

POWER Button

Press to turn the VCR power on and off.

F.FWD (Fast Forward) Button

When tape playback is stopped, press to fast forward the tape at high speed. During tape playback, press to fast forward the tape while the picture stays on-screen. *Details are on page 35.*

PLAY Button

Press to play a tape. Also, press to release Slow, Search, or Still mode and to return to normal playback. *Details are on page 35.*

STOP/EJECT Button

Press once to stop the tape. When tape playback is stopped, press to eject the tape.

REW(ind) Button

When tape playback is stopped, press to rewind the tape at high speed. During tape playback, press to rewind the tape while the picture stays on-screen. *Details are on page 35.*

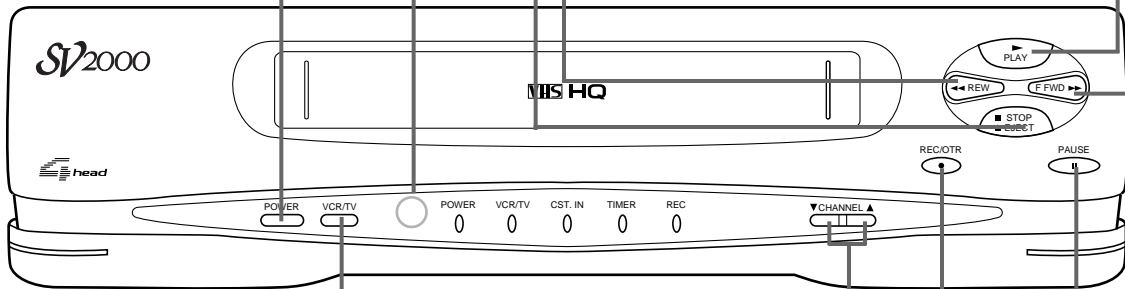

VCR/TV Button

Use to select the signal that your TV receives.

● VCR Position

Use to watch a tape, to watch a program while recording it, or to watch a TV broadcast using the CHANNEL ▲/▼ or Number buttons. The VCR/TV light will appear when the VCR is in VCR position.

● TV Position

Use to watch TV or to watch one program while recording another. *Details are on page 32.*

CHANNEL ▲/▼ Buttons

Press to scan up or down through the VCR's channels.

TRACKING Function

During normal tape playback or slow motion tape playback, press the CHANNEL ▲/▼ buttons to adjust the tracking. *Details are on page 41.*

REC(ord)/OTR Button

Press once to start a recording. *Details are on page 24.* Press repeatedly to start a One-Touch Recording (an immediate recording, 30 minutes to eight hours long) of the channel you are watching. *Details are on page 25.*

PAUSE Button

While recording, press to temporarily stop the recording. Press a second time to resume normal recording. *Details are on page 24.* You can not pause a One-Touch Recording. *Details are on page 25.* During tape playback, press to freeze the picture. Press repeatedly to advance the still picture frame by frame. *Details are on page 35.*

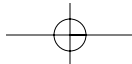

22 Rear Panel

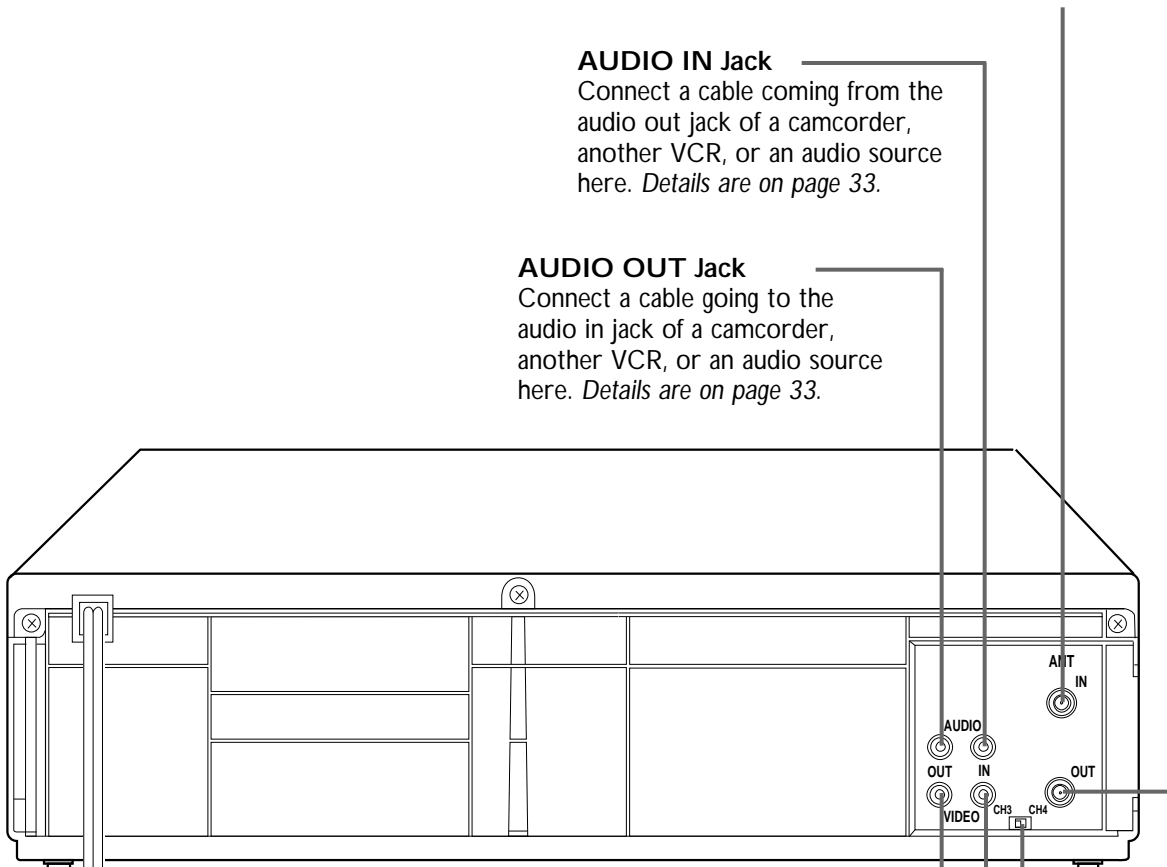

ANT(enna) IN Jack
Connect your antenna or cable here. *Details are on pages six - 10.*

AUDIO IN Jack
Connect a cable coming from the audio out jack of a camcorder, another VCR, or an audio source here. *Details are on page 33.*

AUDIO OUT Jack
Connect a cable going to the audio in jack of a camcorder, another VCR, or an audio source here. *Details are on page 33.*

VIDEO OUT Jack
Connect a cable going to the video in jack of a camcorder, another VCR, or an audio-visual source (laser disc player, video disc player, etc.) here. *Details are on page 33.*

CH3/CH4 Switch
Set to channel 3 or 4 to use your TV with your VCR. Set your TV to the same channel. *Details are on page seven.*

AC Power Cord
Connect to a standard AC outlet to supply power to the VCR.

VIDEO IN Jack
Connect a cable coming from the video out jack of a camcorder, another VCR, or an audio-visual source (laser disc player, video disc player, etc.) here. *Details are on page 33.*

OUT Jack
Use the supplied RF coaxial cable to connect this jack to the Antenna In Jack on your TV or Cable Box/DBS. *Details are on pages six - nine.*

Playing 23

Read and follow the steps below to play a tape.

1

Turn on the TV and set it to channel 3 or 4, whichever channel the CH3/CH4 switch on the back of the VCR is set to.

2

Insert a tape in the VCR. The POWER and CST.IN lights will appear. If the tape's record tab has been removed, the VCR/TV light will appear and playback will begin automatically.

3

If playback does not start automatically, press the VCR/TV button to put the VCR in VCR position (the VCR/TV light will appear). Then, press the PLAY button.

4

Press the STOP button to stop playback.

5

Press the REWIND button to rewind the tape.

6

When the tape has finished rewinding, press the EJECT button to remove the tape.

1 Turn on the TV.

2 Insert a tape.

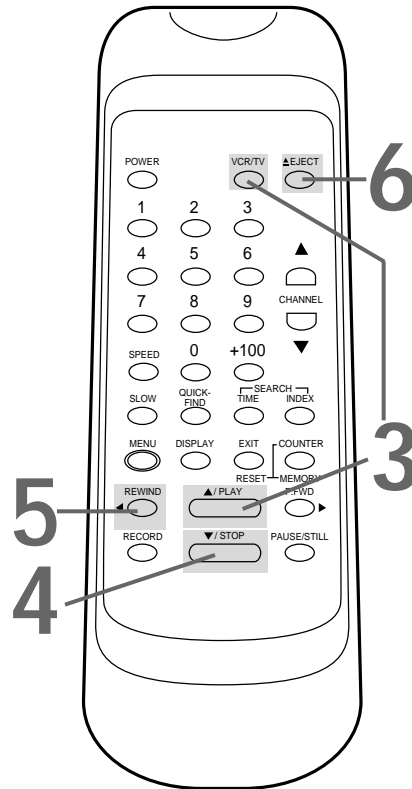

Helpful Hints

- If the tape you want to play is already in the VCR, make sure the VCR power is on and the VCR is in VCR position. (Press the VCR/TV button so that the VCR/TV light appears.) Then, press the PLAY button.
- Other playback options and features are on pages 34 - 41.

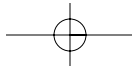

24 Recording

Read and follow the steps below to record a television program.

1

Turn on the TV; set it to channel 3 or 4, whichever the CH3/CH4 switch on the back of the VCR is set to.

2

Insert a tape with its record tab intact (see page five) in the VCR. The POWER and CST.IN lights will appear.

3

Press the VCR/TV button so that the VCR/TV light appears.

4

Press the SPEED button until the desired tape speed appears on-screen. The tape speed will disappear after about five seconds.

You can change the tape speed while the VCR is recording, but some distortion may appear on the tape. *Details about tape speed are on page 44.*

5

Use the CHANNEL ▲/▼ buttons or the Number buttons to select the channel to be recorded.

6

Press the RECORD button once to start recording. The REC(ord) light will appear. If the tape is missing the record tab, the VCR will eject the tape.

7

To pause the recording (for example, during commercials), press the PAUSE/STILL button once. The REC(ord) light will flash.

To resume recording, press the RECORD button or the PAUSE/STILL button again. The REC(ord) light will appear.

8

Press the STOP button to stop recording.

1

 Turn on the TV.

2

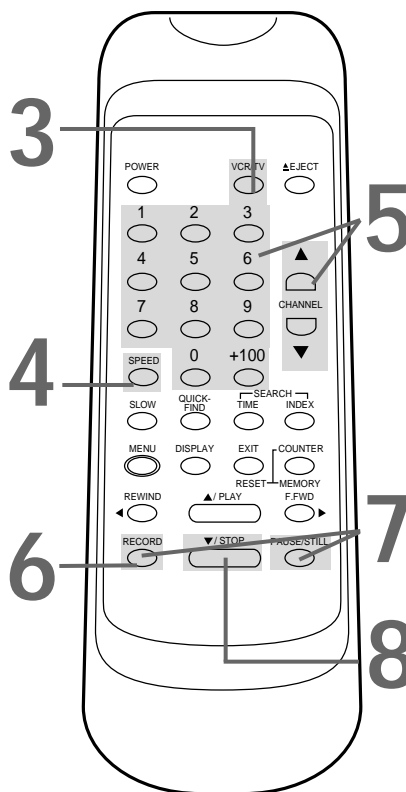
 Insert a tape.

Helpful Hints

- Other recording options are on pages 25 - 33.
- The VCR will record in a preset volume.
- Pause mode will automatically switch to Stop mode after five minutes to protect the VCR and the tape from damage. When a recording is paused, you may review the time remaining with the ■ marks on-screen. Each ■ mark equals one minute remaining. During the last minute of paused recording, the ■ mark will flash.
- If any menu is activated on the TV screen, the RECORD button on the remote control does not function. Press the COUNTER RESET/EXIT button to remove the menu. Then, press the RECORD button.

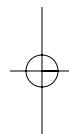
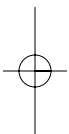

One-Touch Recording 25

The One-Touch Recording function allows you to program an immediate timed recording 30 minutes to eight hours long. Before you begin, make sure:

- Channels are set up.
- The desired recording speed (SP, LP, SLP) has been selected with the SPEED button.
- There is a tape in the VCR. Make sure the tape's record tab is intact and the tape is long enough to record the program(s).
- The VCR is in VCR position. (The VCR/TV light will appear. If it does not, press the VCR/TV button once.)

Starting an OTR

1

Use the CHANNEL (▲/▼) buttons or the Number buttons to select the channel you want to record.

2

Press the REC(ord)/OTR button on the VCR repeatedly until the desired recording length (30 minutes to eight hours) appears in the upper left corner of the screen. Recording will begin immediately.

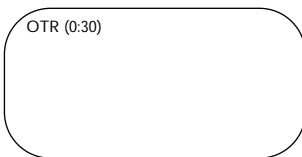

Stopping an OTR

To stop an OTR before recording is finished, press the STOP button on the remote control. To cancel the OTR but continue recording, press the REC(ord)/OTR button **on the VCR** repeatedly until REC appears in the upper left corner of the screen.

2 Press the REC(ord)/OTR button **on the VCR** repeatedly.

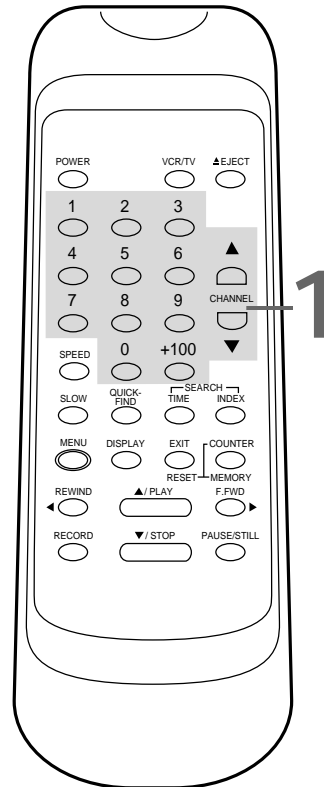

Helpful Hints

- To change the recording length while an OTR is in progress, press the REC(ord)/OTR button **on the VCR** repeatedly until the desired length appears on-screen.
- You can not pause recording during an OTR.
- If the preset time for a timer recording comes up during an OTR, the OTR has priority. The timer recording will not occur.
- To show the time remaining for an OTR, press the DISPLAY button.

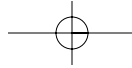

26 Timer Recording

Follow the steps below to program your VCR to record TV programs while you're away from home. You can program up to seven timer recordings. For each one, the VCR will turn itself on, record, and turn itself off automatically. Before you begin make sure:

- Channels are set up.
- The clock is set.
- There is a tape in the VCR. Make sure the tape's record tab is intact and the tape is long enough to record the program(s).
- The VCR is on and in VCR position. The VCR/TV light will appear. If it does not, press the VCR/TV button once. (When you finish programming the timer recording, you must turn off the VCR.)

1

Press the **MENU** button until the **TIMER PROGRAMMING** menu appears. Program numbers that do not have a timer recording stored will flash.

TIMER PROGRAMMING
 PROG. 1 2 3 4 5 6 7
 DATE
 START TIME
 END TIME
 CHANNEL
 REC SPEED

2

Press the **PLAY** button or the **STOP** button repeatedly to select a program number. Then, press the **F.FWD** button. (If you select a program number that already has a timer recording stored, information about that program will appear. Press the **PLAY** button or the **STOP** button to select another program number.)

PROGRAM NUMBER 1
 DATE --/--
 START TIME ---:--
 END TIME ---:--
 CHANNEL --
 REC SPEED --

3

Press the **PLAY** button or the **STOP** button repeatedly to select a **ONCE**, **DAILY**, or **WEEKLY** recording. When the arrow is beside your choice, press the **F.FWD** button.

- **ONCE** - The VCR will record a TV program on any day you choose, up to 12 months away.
- **DAILY** - The VCR will record a TV program at the same time on the same channel every day, Monday through Sunday.
- **WEEKLY** - The VCR will record a TV program at the same time on the same channel every week, for example, every Monday.

PROGRAM NUMBER 1
 ONCE
 DAILY
 →WEEKLY

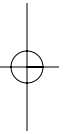
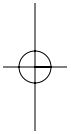
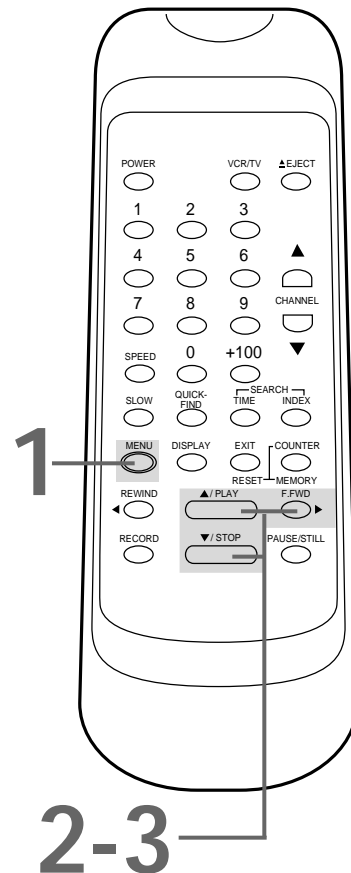

Timer Recording (cont'd) 27

4

Press the **PLAY** button or the **STOP** button repeatedly until the desired month appears. Then, press the **F.FWD** button.

Next, press the **PLAY** button or the **STOP** button repeatedly until the desired day appears. Then, press the **F.FWD** button.

The day of the week will appear automatically. You can not program the VCR to record more than one year in advance.

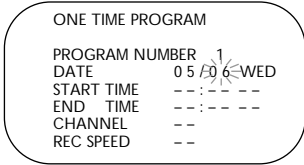

5

Enter the recording's start time.

Press the **PLAY** button or the **STOP** button repeatedly until the desired hour appears. Press the **F.FWD** button. Press the **PLAY** button or the **STOP** button repeatedly until the desired minute appears. Press the **F.FWD** button.

Finally, press the **PLAY** button or the **STOP** button to point to **AM** or **PM**. **AM** or **PM** will flash beside the time. Press the **F.FWD** button.

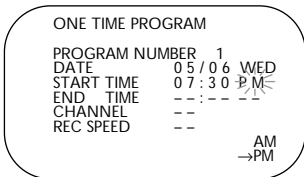

6

Repeat the procedure in step 5 to set the recording's end time.

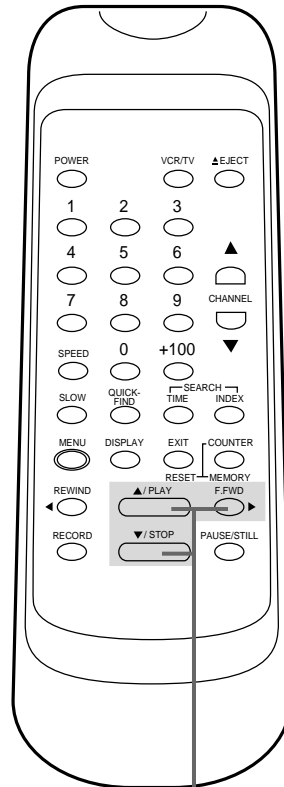
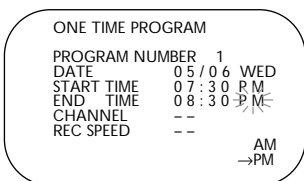

4-6

Instructions continue on page 28.

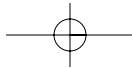

28 Timer Recording (cont'd)

7

Press the **PLAY** button or the **STOP** button repeatedly until the desired channel number appears. Then, press the **F.FWD** button.

- If you are using a standard antenna/cable hookup (as shown on pages six - seven), select the channel of the TV program you want to record.
- If you are recording from line input, select AUX.
- If you are using a Cable Box/DBS, select the Cable Box/DBS output channel (03 or 04). Select the channel you want to record at the Cable Box/DBS. Leave the Cable Box/DBS on for the timer recording. *Details are on page eight.*

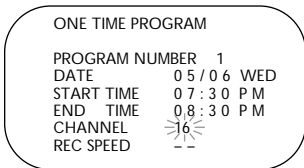

8

Press the **PLAY** button or the **STOP** button repeatedly to select a **tape speed**. The arrow will appear beside your choice. The selected tape speed will flash beside REC SPEED.

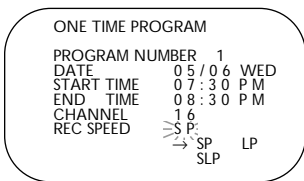

9

Press the **COUNTER RESET/EXIT** button.

10

Press the **POWER** button to turn off the **VCR**. The **TIMER** light will appear. (The **TIMER** light will flash if there is not a tape in the **VCR**.)

If a timer recording will take place several hours or days from now, you may use the **VCR** until time for the timer recording. Just make sure you turn off the **VCR** about five minutes before the scheduled start time.

The VCR must be off for a timer recording to take place! Make sure a tape is in the VCR.

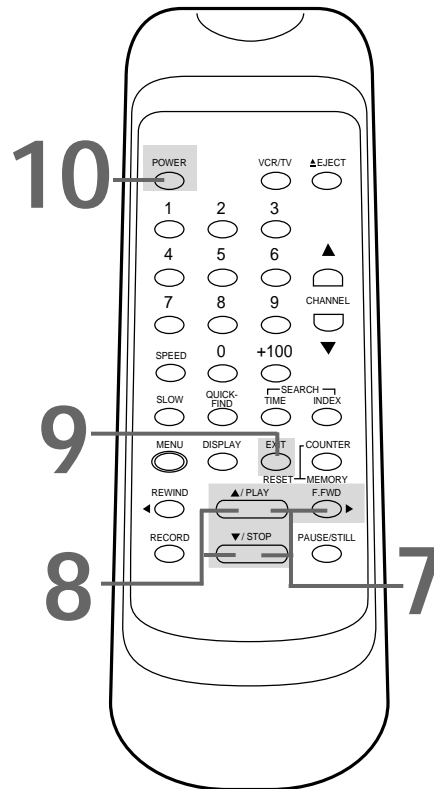

Helpful Hints

- The **TIMER PROGRAMMING** menu will not appear at step 1 if the clock is not set. Follow the steps on pages 14 - 15 to set the clock.
- Enter the information while the space is flashing.
- Press the **REWIND** button to go back one step from the current step during steps 2-8.
- To stop a started timer recording, press the **STOP/EJECT** button on the **VCR**.
More Helpful Hints are on page 42.

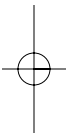
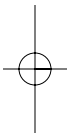

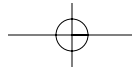

Timer Recording (cont'd) 29

..... Cancelling a Timer Recording

1

Press the MENU button so that the TIMER PROGRAMMING menu appears.

2

Press the PLAY button or the STOP button until the program number you want to cancel appears on-screen.

3

While the program number is flashing, press the REWIND button to cancel the timer recording.

4

Press the COUNTER RESET/EXIT button to exit.

To cancel a timer recording

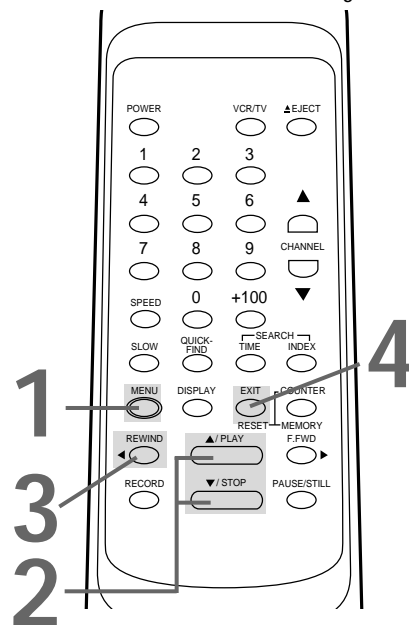

Correcting a Timer Recording

If you need to correct a timer recording after you have finished setting the program, follow these steps. Make sure the VCR is on and is in VCR position. (The VCR/TV light will appear. If it does not, press the VCR/TV button once.)

1

Press the MENU button so that the TIMER PROGRAMMING menu appears.

2

Press the PLAY button or the STOP button until the timer recording you want to correct appears on-screen.

3

Select the information you want to change using the F.FWD button. Press the REWIND button to go back one step. (There is an exception. Do not press the REWIND button while the program number is flashing. If you do, you will cancel the timer recording completely.)

4

While the information is flashing, enter the correct information by pressing the PLAY button or the STOP button.

5

When all the information is correct, press the COUNTER RESET/EXIT button to exit. Turn off the VCR before the timer recording.

To correct a timer recording

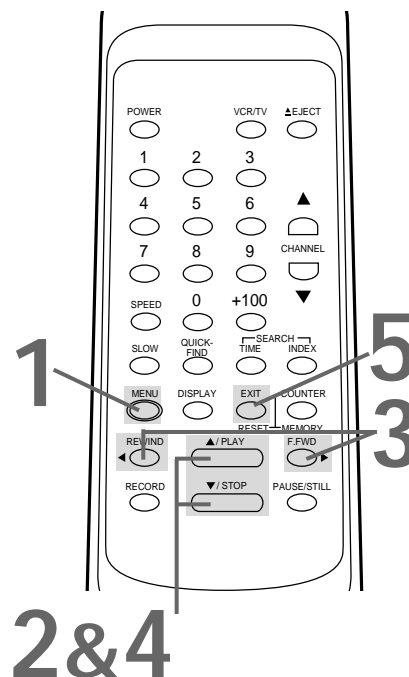

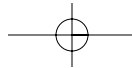

30 Auto Return

Follow the steps below to make the VCR rewind to the beginning of the programs after it has finished all timer recordings. Make sure:

- The VCR is on and is in VCR position. (The VCR/TV light will appear. If it does not, press the VCR/TV button once.)

1

Press the **MENU** button repeatedly until the **VCR SET UP** menu appears.

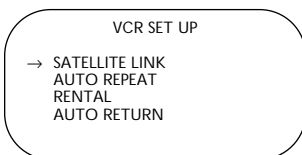

2

Press the **PLAY** button or the **STOP** button repeatedly to select **AUTO RETURN**.

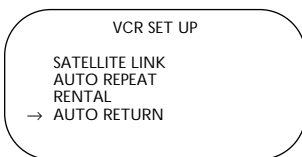

3

Press the **F.FWD** button so that **[AUTO]** appears next to **AUTO RETURN** on-screen.

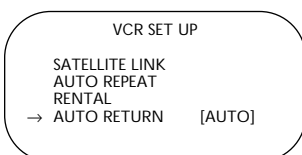

4

Press the **COUNTER RESET/EXIT** button to exit.

Remember to turn off the VCR before the timer recording. When all the timer recordings are completed, the **TIMER** light will flash and the VCR will rewind the tape to the beginning of the recorded programs.

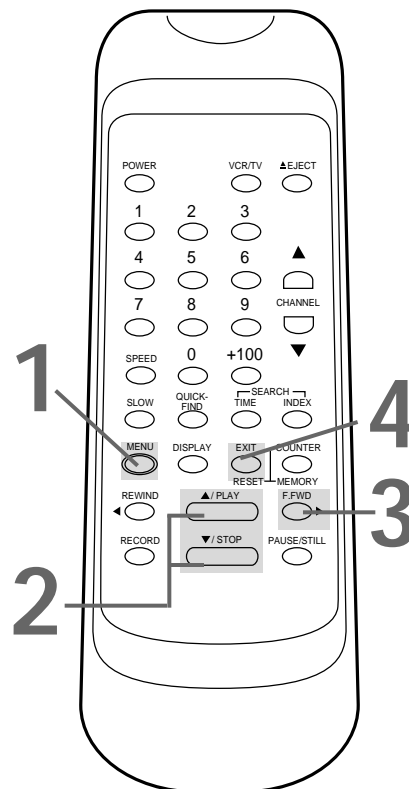

Helpful Hints

- If additional timer recordings are programmed to take place later, the Auto Return function will not operate until all the programs are recorded.
- To cancel this function, follow steps 1 - 2 above. At step 3, press the F.FWD button so that [AUTO] no longer appears beside AUTO RETURN. Press the COUNTER RESET/EXIT button to exit.

Auto Satellite Link Using a Satellite Tuner 31

If you connect your VCR to a satellite tuner that has the Electronic Program Guide, the VCR will turn itself on, record, then turn itself off. First, read the owner's manual of your satellite tuner; then, follow these steps to set up your VCR. Before you begin:

- Use audio and video cables to connect the AUDIO/VIDEO IN jacks on the back of the VCR to the AUDIO/VIDEO OUT jacks on the satellite tuner.
- Press the SPEED button to select the desired tape speed (SP, LP, or SLP).

1

Set the program to be recorded on the satellite tuner. See your satellite tuner owner's manual for details.

2

Press the MENU button repeatedly until the VCR SET UP menu appears.

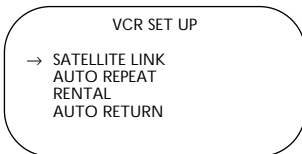

3

Press the PLAY button or the STOP button repeatedly to select SATELLITE LINK.

4

Press the F.FWD button so that [ON] appears beside SATELLITE LINK. After one second, the VCR will turn itself off and the TIMER light will appear on the VCR display panel.

1 Set the program to be recorded on the satellite tuner.

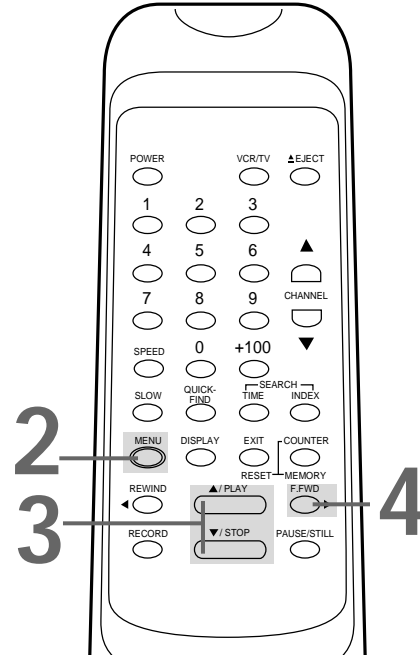

Helpful Hints

- To exit a stand-by mode of the Auto Satellite Link, press the POWER button to turn on the VCR. The VCR sets SATELLITE LINK to OFF automatically.
- To stop an Auto Satellite Link recording that is in progress, press the STOP/EJECT button on the VCR.
- If the preset time for an Auto Satellite Link comes up during a timer recording, the timer recording has priority.
- If a program has copy guard protection, it may not record clearly.
- If noise appears on the TV screen when you view a program, connect the satellite tuner directly to the TV.
- When you use this feature, the first few seconds of a program may not be recorded.
- If your satellite tuner has the synchronized timer feature by the broadcasting time of a program, refer to the tuner's owner's manual.

32 Recording One Channel/Watching Another

1

Press the **RECORD** button to start a recording. Details are on page 24.

2

Press the **VCR/TV** button to put the VCR in TV position. The VCR/TV light will disappear.

3

Use the TV remote control to select the channel you want to watch at the TV.

4

To return to the channel being recorded, use the TV remote control to select channel 3 or 4, whichever channel the CH3/CH4 switch on the back of the VCR is set to.

5

Press the **VCR/TV** button on the VCR remote control to put the VCR in VCR position. The VCR/TV light will appear. The channel being recorded will appear on-screen.

6

To stop recording, press the **STOP** button.

3

Select the channel you want to watch at the TV.

4

Set the TV to channel 3 or 4.

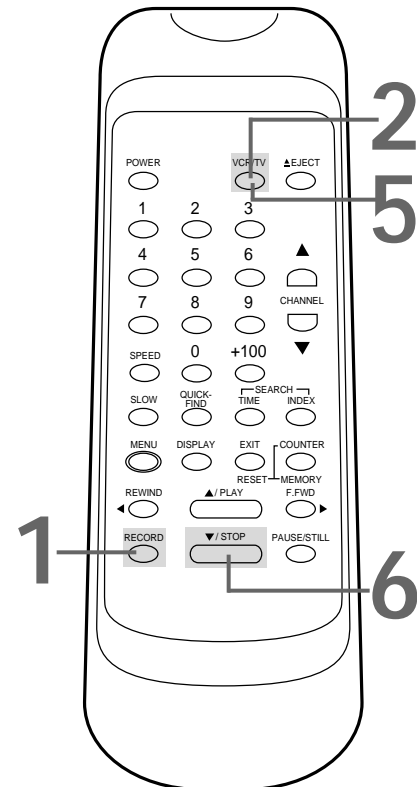

Helpful Hint

- If you use a Cable Box/DBS, you may not be able to watch one channel while recording another. Details are on pages eight - nine.

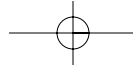

Rerecording (Tape Duplication) 33

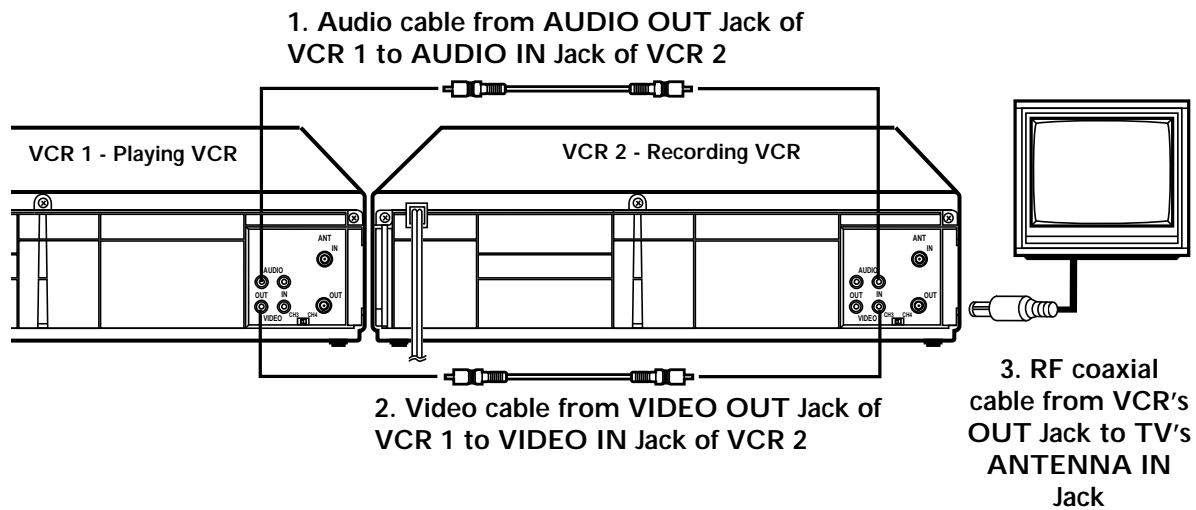

1

VCR 1 will play your tape. Insert a prerecorded tape in VCR 1. If the tape does not have a record tab, playback begins. If this happens, press the STOP/EJECT button on VCR 1 once.

2

VCR 2 will record your tape. Insert a blank tape in VCR 2. Make sure the record tab is intact (details are on page five). Make sure the VCR 2 power is on and VCR 2 is in VCR position. (The VCR/TV light will appear. If it does not, press the VCR/TV button once.)

3

Turn on the TV and set it to channel 3 or 4, whichever channel the CH3/CH4 switch on VCR 2 is set to.

4

Point the remote control at VCR 2. Press the Number buttons 0, 0. AUX will appear on-screen.

5

Point the remote control at VCR 2. Use the SPEED button to select SP, LP, or SLP.

6

Press the PLAY button on VCR 1 and the REC(ord)/OTR button on VCR 2 at the same time.

7

To stop recording, press the STOP/EJECT button on VCR 2 once, then stop the tape on VCR 1.

Helpful Hints

- Unauthorized recording of copyrighted television programs, video tapes, or other materials may infringe on the rights of copyright owners and violate copyright laws.
- Audio and video cables are not supplied.
- The illustration uses two VCRs just like yours. Different VCRs may operate differently.

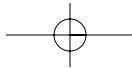

34 Repeat Play

Follow the steps below to program the VCR to play a tape over and over. Make sure:

- The VCR is on and is in VCR position. The VCR/TV light will appear on the front panel. If it does not, press the VCR/TV button once.
- There is a tape in the VCR.

1

Press the **MENU** button repeatedly until the **VCR SET UP** menu appears.

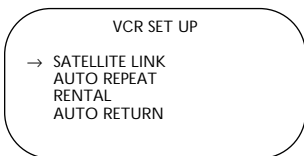

2

Press the **PLAY** button or the **STOP** button repeatedly to select **AUTO REPEAT**.

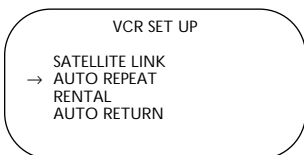

3

Press the **F.FWD** button so that **[ON]** appears next to **AUTO REPEAT** on-screen. Tape playback will begin immediately. **AUTO REPEAT ►** will appear on-screen briefly. (If you are fast forwarding or rewinding the tape, you must first press the **COUNTER RESET/EXIT** button to exit, then press the **PLAY** button to begin tape playback.)

The VCR will play the tape to the end, rewind it, then play it again. (TV programming will appear on-screen while the tape is rewinding.)

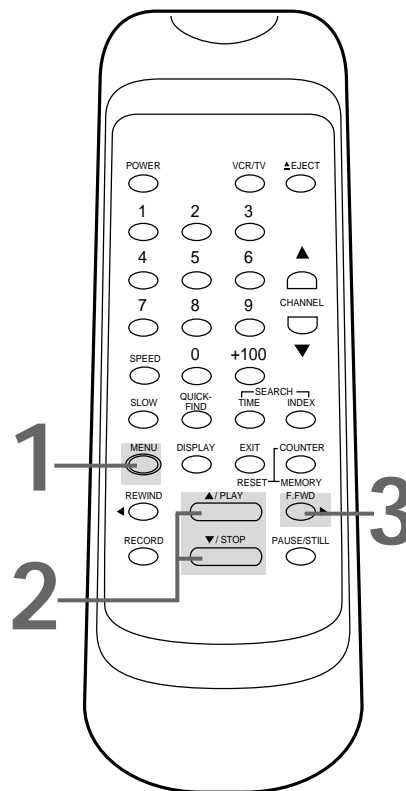

Helpful Hints

- To cancel **AUTO REPEAT**, follow steps 1 - 2 above. At step 3, press the **F.FWD** button so that **[ON]** no longer appears beside **AUTO REPEAT**. Press the **COUNTER RESET/EXIT** button to exit.
- The **COUNTER MEMORY** button does not function if **AUTO REPEAT** is set to **[ON]**.
- The real-time counter memory is cancelled if **AUTO REPEAT** is set to **[ON]**.

Special Effects Playback 35

Forward and Reverse Searching (SP/LP/SLP)

1

During tape playback, press and release the **F.FWD** button or the **REWIND** button. A fast forward or reverse picture search will begin.

2

To return to playback, press the **PLAY** button.

Super High Speed Searching (LP/SLP)

1

During tape playback, press the **F.FWD** button or the **REWIND** button, then press again. The VCR will now search in super high speed.

2

To return to playback, press the **PLAY** button.

Viewing a Still Picture

1

During tape playback, press the **PAUSE/STILL** button. A still picture will appear on-screen.

*NOTE: You can advance the still picture frame by frame by pressing the **PAUSE/STILL** button repeatedly.*

2

To release the still picture and return to normal playback, press the **PLAY** button.

Viewing a Slow Motion Picture

1

During tape playback, press the **SLOW** button. The tape will play in slow motion.

*NOTE: You can control the speed of slow motion playback by pressing the **F.FWD** button (faster) or the **REWIND** button (slower).*

2

To release Slow mode and return to normal playback, press the **PLAY** button.

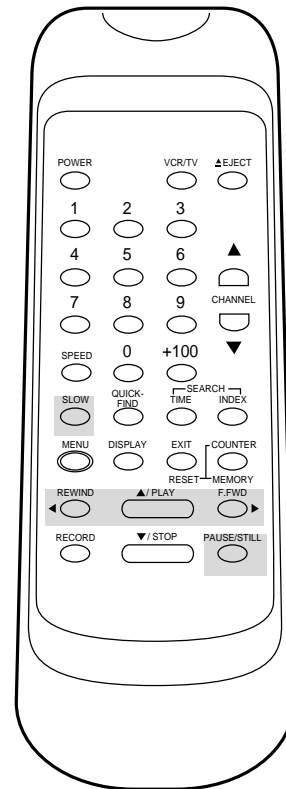

Helpful Hints

- Slow and Still modes will automatically switch to Stop mode after five minutes to protect the VCR and the tape from damage.
- SP/LP/SLP means this feature will work with tapes recorded in Standard Play, Long Play, or Super Long Play.
- LP/SLP means this feature will work with tapes recorded in Long Play or Super Long Play. For details about tape speed, see page 44.

36 Rental Play

This function enables you to improve the picture quality when playing worn cassettes such as those rented from a video store.

Make sure:

- The VCR is on and is in VCR position. The VCR/TV light will appear. If it does not, press the VCR/TV button once.
- There is a tape in the VCR.

1

During tape playback, press the MENU button repeatedly until the VCR SET UP menu appears.

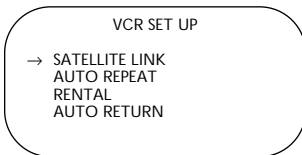

2

Press the PLAY button or the STOP button repeatedly to select RENTAL. Then, press the F.FWD button.

The menu will disappear, and RENTAL ON or RENTAL OFF will appear on-screen for five seconds. Each press of the F.FWD button within five seconds will turn RENTAL to ON or OFF.

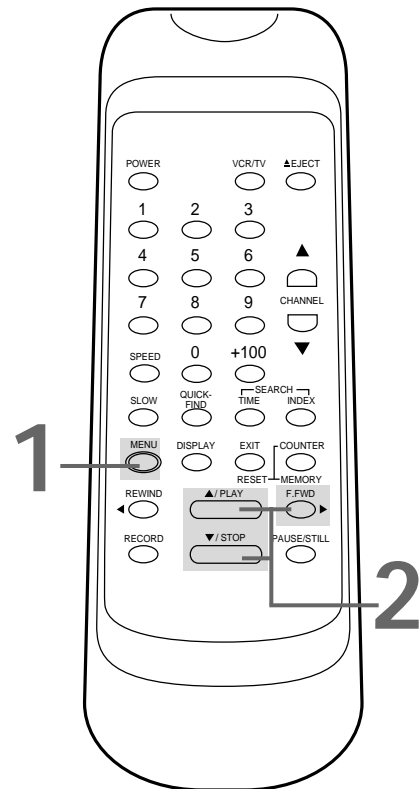
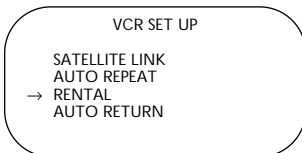

Helpful Hint

- You may only set RENTAL to ON or OFF during tape playback.

Real-Time Counter Memory 37

Follow the steps below to reset the real-time counter to zero at a tape location you want to refer to later. Make sure:

- The VCR is on and is in VCR position. The VCR/TV light will appear. If it does not, press the VCR/TV button once.
- There is a tape in the VCR.

1

Play, fast forward, or rewind a tape to the location that you would like to refer to later. **Press the STOP button to stop the tape.**

2

Press the **COUNTER RESET/EXIT** button to reset the real-time counter to zero.

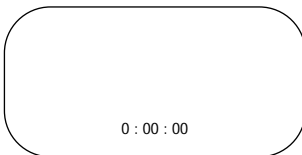

3

Press the **COUNTER MEMORY** button so that **M** appears on-screen beside the real-time counter.



4

To go to a tape location where the real-time counter was reset to zero, press the **REWIND** button or the **F.FWD** button when playback is stopped.

When the tape reaches the point at which the real-time counter was reset to zero, the tape will stop.

Press the PLAY button to watch the tape.

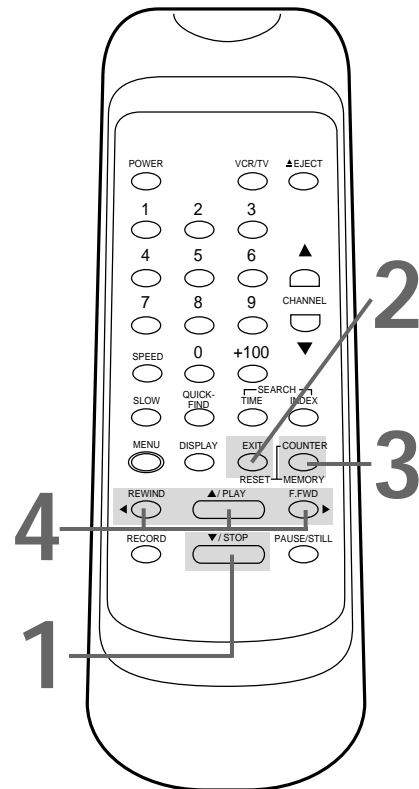

Helpful Hints

- You may only set the real-time counter memory at one location at a time. If you set the real-time counter to zero at a second location, the previous real-time counter to zero setting will be erased.
- To erase the real-time counter memory, press the **COUNTER MEMORY** button repeatedly so that the **M** disappears from the screen.
- The **COUNTER MEMORY** button does not function if **AUTO REPEAT** is set to **[ON]**.

38 Index Search

When you make a recording, the VCR places an index mark at the beginning of the recording. Essentially, an index mark is a type of "bookmark" for your tape. This feature is useful if you have several different programs recorded on a single tape.

You may skip over programs by following the steps below. Before you begin, make sure:

- The VCR is on and is in VCR position. (The VCR/TV light will appear. If it does not, press the VCR/TV button once.)
- There is a tape in the VCR.

1

Press the **MENU** button repeatedly until the **SEARCH SELECT** menu appears.

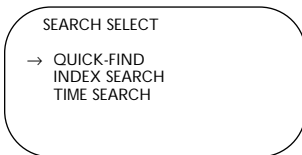

2

Press the **PLAY** button or the **STOP** button repeatedly to select **INDEX SEARCH**. Then, press the **F.FWD** button.

3

Within 30 seconds, press the **PLAY** button or the **STOP** button repeatedly until the number of programs that you want to skip appears beneath **INDEX SEARCH** on-screen. (Example: 03 for three programs)

4

While the number of programs is flashing, press the **REWIND** button or the **F.FWD** button.

The VCR begins rewinding or fast forwarding to the beginning of the desired program. When the program is reached, the VCR will start playback automatically.

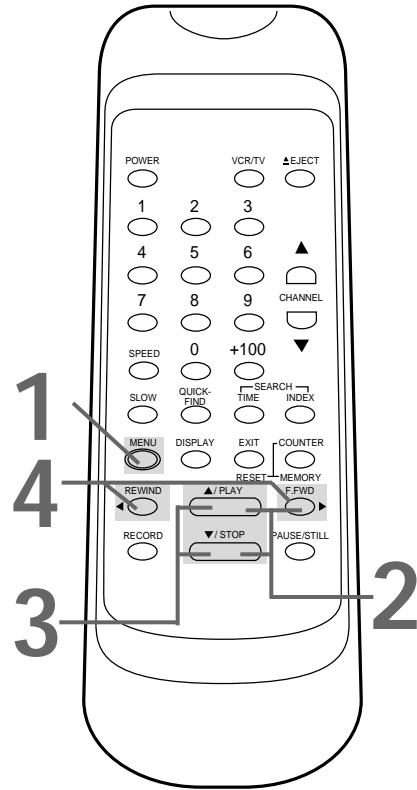

Helpful Hints

- You may also activate the Index Search by pressing the **INDEX SEARCH** button. Then, continue from step 3.
- Every time an index mark is passed, the number of programs beneath **INDEX SEARCH** on-screen decreases by one.
- Up to 20 index marks may be stored and searched.
- This function is not available during recording.
- Press the **STOP** button to stop the search.
- To exit Index Search mode, press the **COUNTER RESET/EXIT** button.
- The time gap between index marks should be greater than 1 minute for SP recording, 2 minutes for LP recording, and 3 minutes for SLP recording.

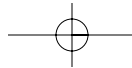

Time Search 39

The Time Search function allows you to go to a specific point on a tape. You will enter the exact amount of playback time that you wish to skip in order to reach the specified point.

Make sure:

- The VCR is on and is in VCR position. (The VCR/TV light will appear. If it does not, press the VCR/TV button once.)
- There is a tape in the VCR.

1

Press the **MENU** button repeatedly until the **SEARCH SELECT** menu appears.

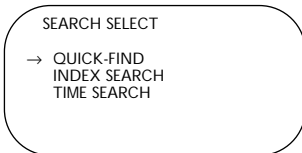

2

Press the **PLAY** button or the **STOP** button repeatedly to select **TIME SEARCH**. Then, press the **F.FWD** button.



3

Within 30 seconds, press the **PLAY** button or the **STOP** button repeatedly until your desired length of time appears. (Example: 2:50 for 2 hours 50 minutes) You may also press and hold the **PLAY** button or the **STOP** button until you reach the desired length of time.

4

Within 30 seconds, press the **REWIND** button or the **F.FWD** button. The VCR begins rewinding or fast forwarding to the specified point. The time counts down on-screen beneath **TIME SEARCH** as the searching progresses. When 0:00 appears beneath **TIME SEARCH**, the VCR will start playback automatically.

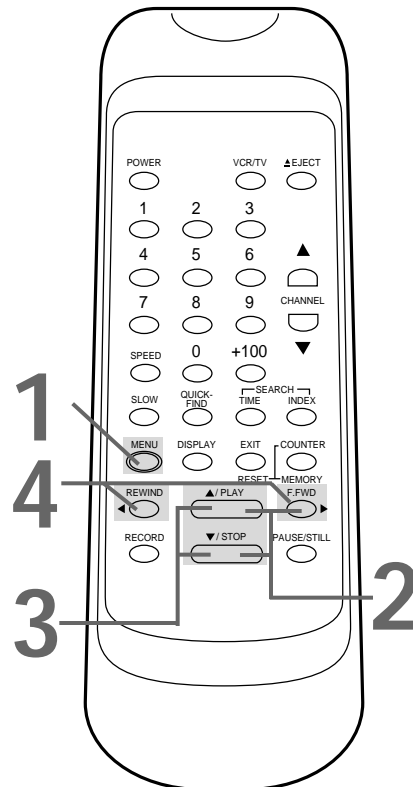

Helpful Hints

- You may also activate the Time Search by pressing the **TIME SEARCH** button. Then, continue from step 3.
- You can set a Time Search for up to 9 hours, 59 minutes (9:59).
- Time Search is not available during recording.
- To exit Time Search mode, press the **COUNTER RESET/EXIT** button.
- To cancel a Time Search already in progress, press the **STOP** button.

40 Quick Find

The Quick Find feature locates the beginning of each recording on a tape, then plays the first portion of the recording at high speed for 30 seconds. After it plays the portion, the VCR fast forwards the tape to the next recording. This process is repeated until the end of the tape is reached, or until you stop the Quick Find.

To start a Quick Find, press the QUICK-FIND button on the remote control, or follow the steps below.

1

Press the **MENU** button repeatedly until the **SEARCH SELECT** menu appears.

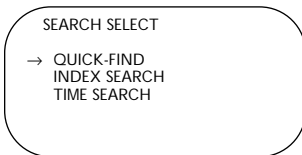

2

Press the **PLAY** button or the **STOP** button repeatedly to select **QUICK-FIND**, then press the **F.FWD** button. The VCR will fast forward the tape to the beginning of the next recording. The VCR will play the tape at high speed for 30 seconds, then go to the next recording.

To skip immediately to the beginning of the next recording on the tape, press the **QUICK-FIND** button on the remote control.

3

To resume normal tape playback, press the **PLAY** button.

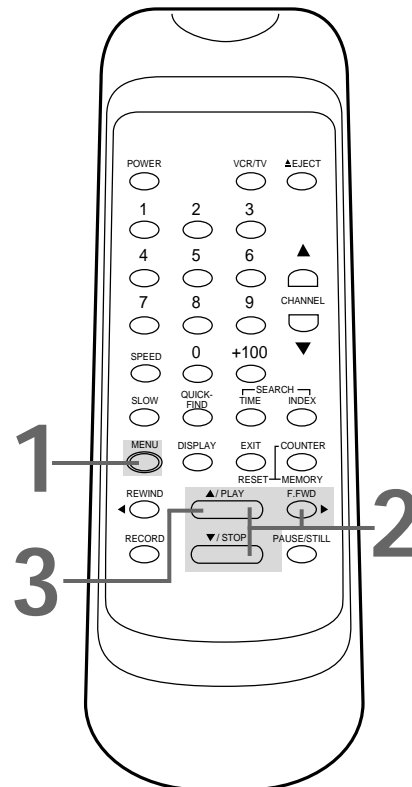

Helpful Hints

- There must be a tape in the VCR.
- This function will not operate during a recording.
- To cancel a Quick Find that is in progress, press the **STOP** button.
- When the end of a tape is reached during a Quick Find, the VCR will rewind the tape to the beginning, eject the tape, and turn itself off. If a real-time counter memory is set, the VCR will rewind the tape to the point at which the real-time counter was set to zero, then stop.

Automatic Playback Features 41

Automatic Playback

When you put a tape in the VCR, the power will come on automatically. If the tape's record tab is missing, playback will begin. (If a timer recording is set, you may have to press the POWER button to turn on the VCR. Make sure you turn off the VCR for the timer recording later. If you insert a tape without a record tab when a timer recording is set, the VCR will eject the tape.)

Automatic Rewind, Eject, Off

When a tape is played, fast forwarded, or recorded to its end, the VCR will rewind the tape to the beginning, eject the tape, and turn itself off.

If the real-time counter memory is set, the VCR will only rewind the tape to the point at which the counter is set to zero, then stop. The VCR will not eject the tape or shut itself off.

Tape Eject

A tape can be ejected with the VCR power on or off (but the VCR must be plugged in). If a Timer Recording is programmed, a tape can only be ejected with the power on. Be sure to insert a tape for the Timer Recording, then turn off the VCR power.

Automatic Tracking Adjustment

The VCR automatically adjusts tracking to give you the best possible picture quality. With some recordings, however, you may get a better picture using the manual tracking controls (see below).

Manual Tracking

To adjust the tracking manually, press the CHANNEL (▲/▼) buttons **on the VCR** during playback.

NOTES:

- Tracking is returned to automatic tracking adjustment when a tape is inserted or when the STOP button is pressed to halt playback.
- Automatic tracking adjustment will not work during slow motion playback. Instead, use the CHANNEL (▲/▼) buttons on the VCR or on the remote control to reduce noise lines in slow motion playback.
- Manual tracking will not operate when the VCR is in Still mode.
- Use the CHANNEL (▲/▼) buttons on the VCR or on the remote control to remove vertical jitter in a Still picture.

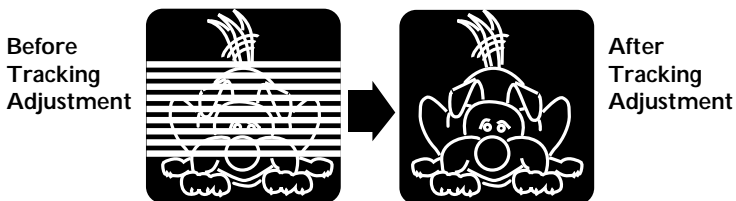

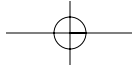

42 Helpful Hints

.....
 If you are having problems with your product, check this list of problems and possible solutions before requesting service. You may be able to solve the problem yourself.

If you need to call a customer service representative, please know the model number and serial number of your product before you call. This information is displayed on the back of the product. Also, please take a moment to identify the problem you are having, and be prepared to explain this to the representative. If you believe the representative will need to help you with operations, please stay near the product. Our representatives will be happy to assist you.

The VCR has no power.

- Make sure the power plug is completely connected to an AC (alternating current) outlet.
- Make sure the power is turned on.

A power failure occurred.

- Follow the steps on page 11 to select a language and set up channels, if necessary. Then, follow the steps on pages 14 - 15 to reset the clock.
- Timer recordings may be lost if the power fails for more than one minute. Reprogram the timer recordings. *Details are on pages 26 - 29.*

The remote control will not operate the VCR.

- Aim the remote control directly at the VCR's remote sensor. *Details are on page 21.*
- Remove all obstacles between the remote control and the VCR.
- Inspect and/or replace the batteries in the remote control. *Details are on page five.*

The VCR does not respond normally to the remote control. (For example, the VCR may change channels multiple times when you press the CHANNEL ▲ button once.)

- Install new batteries (preferably alkaline) in the remote control.

The motor (cylinder) rotates even when the VCR is in Stop mode.

- To enable the quick play mechanism, the cylinder will rotate for about five minutes. This is normal. The quick play mechanism switches the tape mechanism from Stop to Play in just one second.

A TV program cannot be recorded.

- Check the connections between the VCR, TV, antenna/cable, and Cable Box/DBS, if applicable. *Details are on pages six - 10.*
- Make sure the tape has a record tab. *Details are on page five.*

The VCR will not perform a timer recording.

- Make sure the recording start and stop times are set correctly. *Details are on pages 26 - 29.*
- Make sure a tape is in the VCR and the tape has a record tab. *Details are on page five.*
- Make sure the VCR power is off.
- Make sure the clock is set. *Details are on pages 14 - 15.*
- The VCR may not perform or continue a timer recording if a power interruption of more than one minute occurs before or during the timer recording, even if the power comes back on afterward. Set up channels and reset the clock before re-programming the timer recording(s).
- Finish programming a timer recording at least five minutes before the recording is scheduled to begin.
- If, after programming a timer recording, you turn off the VCR without inserting a tape, the TIMER light will blink. Insert a tape with the record tab intact.
- Noon is 12 p.m. Midnight is 12 a.m.
- If the tape runs out before the recording ends, the VCR will stop, eject the tape, and turn itself off. The TIMER light will blink.
- If a tape without a record tab is inserted, the VCR will eject the tape. The TIMER light will blink. Insert a tape that allows recording.
- If the preset time for a timer recording comes up during a One-Touch Recording, the OTR has priority.
- When two timer recordings overlap, the timer recording with the earliest start time will have priority. When the earliest program has finished recording, the next program number will begin recording.

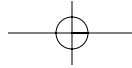

Helpful Hints (cont'd) 43

.....
Tape cannot be removed.

- Make sure the power plug is completely connected to an AC (alternating current) outlet.
- You have set a timer recording. Turn on the VCR power, then eject the tape. Be sure to insert a tape and turn off the VCR for your timer recording.

Tape cannot be inserted.

- Insert the tape, window side up, with the record tab facing you.
- Make sure a tape isn't already in the VCR by pressing the STOP/EJECT button on the VCR or the EJECT button on the remote control.
- Gently push on the center of the tape when putting it in the VCR. Never force the tape into the VCR.
- If a timer recording is set, the VCR will not accept a tape that does not have a record tab. You may only insert a tape with the record tab intact.

VCR ejects the tape when the RECORD button is pressed or when the VCR power is turned off to set a timer recording.

- Make sure the tape has a record tab. *Details are on page five.*

There is no playback picture, or the playback picture is noisy or contains streaks.

- Make sure the TV is on the same channel as the VCR's CH3/CH4 switch. *Details are on page seven.*
- Make sure the VCR is in VCR position. (The VCR/TV light will appear. If it does not, press the VCR/TV button once.)
- Make sure channel 3 or 4 is properly adjusted.
- Adjust the tracking. *Details are on page 41.*

TV programs cannot be watched normally.

- Press the VCR/TV button to put the VCR in TV position. (The VCR/TV light will disappear.)
- Check the connections between the VCR, TV, antenna/cable, and Cable Box/DBS (if applicable). *Details are on pages six - 10.*

The reception on all channels is poor.

- You may need to tune your TV again.

Line Input

- If you accidentally enter Line Input mode (AUX will appear on your TV screen briefly), press the CHANNEL (▲/▼) buttons or use the Number buttons to select another channel.

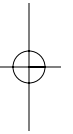
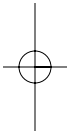

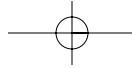

44 Glossary

AUDIO IN/OUT Jacks: jacks located on the back of the VCR which are used to record audio from another source (IN) or to send audio to another source (OUT).

Automatic Channel Setup: process in which the VCR scans all available channels and places the ones you receive in its memory. Then, when you push the CHANNEL (▲/▼) buttons, you only scan through channels you receive.

Bands: settings that allow you to tune channels.

- **Antenna** – VHF (very high frequency; channels 2-13) and UHF (ultra high frequency; channels 14-69).
- **Cable** – all standard channels can be received without a Cable Box/DBS.

Cable Box/DBS Output Channel: Channel 3 or 4.

Dubbing: copying a tape using a second VCR.

Frame: a single still picture.

HQ: high quality; a feature in the VCR circuitry which provides enhanced picture detail.

Line Input: The channel to which you set your VCR during dubbing. The line input channel is always channel 00.

If you accidentally enter Line Input mode (AUX will appear on your TV screen briefly), press the CHANNEL (▲/▼) buttons or use the Number buttons to select another channel.

Mode: a VCR operation.

OTR: One-Touch Recording; programming a timed recording that starts immediately and records for 30 minutes to eight hours, whichever you specify.

Remote Control: the small electronic unit that came with your VCR; allows you to operate your VCR from a distance.

RF coaxial cable: The cable supplied with your VCR. Use it to connect your VCR to your TV (or Cable Box/DBS, if applicable). The supplied cable is a snap-on type. However, you may also use a screw-on type if you prefer.

Special Effects: forward and reverse searching; viewing a still picture; slow motion playback.

Tape Speeds: how fast the tape travels during a recording.

- SP (standard play) – fastest tape speed (recording time for a T120 tape is approximately two hours); best picture quality.
- LP (long play) – average tape speed (recording time for a T120 tape is approximately four hours).
- SLP (super long play) – slowest tape speed (recording time for a T120 tape is approximately six hours).

VCR: video cassette recorder.

VIDEO IN/OUT Jacks: jacks located on the back of the VCR which are used to record video from another source (IN) or to send video to another source (OUT).

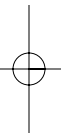
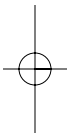

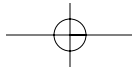

Specifications 45

Video Heads

Four heads

Video Signal

EIA standards; NTSC color

Antenna

VHF/UHF – 75 ohm external antenna terminal

VHF Output Signal

Channel 3 or 4 (switchable)

75 ohms unbalanced

Power Requirement

120V AC; 60Hz

Power Consumption

16W

Operating Temperature

41°F (5°C) to 104°F (40°C)

Relative Humidity

10% to 80%

Weight

5.5 lbs. (2.5 kg.)

Dimensions

14-3/16" (W) x 3-1/16" (H) x 9-3/16" (D)

(360 mm x 92mm x 230mm)

Tuner Broadcast Channels

VHF 2-13, UHF 14-69

Cable TV Channels

2-13

Midband: A – 1

Superband: J – W

Hyperband: A-5 – A-1

Special Channel: 5A

Ultraband: 37 – 94, 100 – 125

NOTE: Designs and specifications are subject to change without notice.

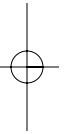
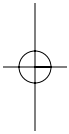

46 Limited Warranty

VIDEO CASSETTE RECORDER

90 Days Free Labor/One Year Parts Exchange. This product must be carried in for repair.

WHO IS COVERED?

You must have proof of purchase to receive warranty service. A sales receipt or other document showing that you purchased the product is considered proof of purchase.

WHAT IS COVERED?

Warranty coverage begins the day you buy your product. For 90 days thereafter, all parts will be repaired or replaced, and labor is free. From 90 days to one year from the day of purchase, all parts will be repaired or replaced, but you pay for all labor charges. After one year from the day of purchase, you pay for the replacement or repair of all parts, and for all labor charges.

All parts, including repaired and replaced parts, are covered only for the original warranty period. When the warranty on the product expires, the warranty on all replaced and repaired parts also expires.

WHAT IS EXCLUDED?

Your warranty does not cover:

- labor charges for installation or setup of the product, adjustment of customer controls on the product, and installation or repair of antenna systems outside of the product.
- product repair and/or part replacement because of misuse, accident, unauthorized repair or other cause not within the control of Philips Consumer Electronics Company.
- reception problems caused by signal conditions or cable or antenna systems outside the unit.
- a product that requires modification or adaptation to enable it to operate in any country other than the country for which it was designed, manufactured, approved and/or authorized, or repair of products damaged by these modifications.
- incidental or consequential damages resulting from the product. (Some states do not allow the exclusion of incidental or consequential damages, so the above exclusion may not apply to you. This includes, but is not limited to, prerecorded material, whether copyrighted or not copyrighted.)
- damage caused by the use of non-VHS tapes or tapes that have not been tested and labeled for use in two, four, six, and eight hour VHS recorders.
- a product that is used for commercial or institutional purposes (including but not limited to rental purposes).

WHERE IS SERVICE AVAILABLE?

Warranty service is available in all countries where the product is officially distributed by Philips Consumer Electronics Company. In countries where Philips Consumer Electronics Company does not distribute the product, the local Philips service

organization will attempt to provide service (although there may be a delay if the appropriate spare parts and technical manual(s) are not readily available).

MAKE SURE YOU KEEP...

Please keep your sales receipt or other document showing proof of purchase. Attach it to this owner's manual and keep both nearby. Also keep the original box and packing material in case you need to return your product.

BEFORE REQUESTING SERVICE...

Please check your owner's manual before requesting service. Adjustments of the controls discussed there may save you a service call.

TO GET WARRANTY SERVICE IN U.S.A., PUERTO RICO OR U.S. VIRGIN ISLANDS...

Take the product to a Philips factory service center (see enclosed list) or authorized service center for repair. When the product has been repaired, you must pick up the unit at the center. Centers may keep defective parts.

(In U.S.A., Puerto Rico and U.S. Virgin Islands, all implied warranties, including implied warranties of merchantability and fitness for a particular purpose, are limited in duration to the duration of this express warranty. Because some states do not allow limitations on how long an implied warranty may last, this limitation may not apply to you.)

TO GET WARRANTY SERVICE IN CANADA...

Please contact Philips at:

1-800-661-6162 (French Speaking)

1-800-363-7278 (English Speaking)

(In Canada, this warranty is given in lieu of all other warranties. No other warranties are expressed or implied, including any implied warranties of merchantability or fitness for a particular purpose. Philips is not liable under any circumstances for any direct, indirect, special, incidental, or consequential damages, howsoever incurred, even if notified of the possibility of such damages.)

REMEMBER...

Please record below the model and serial numbers found on the product. Also, please fill out and mail your warranty registration card promptly. It will be easier for us to notify you if necessary.

MODEL # _____

SERIAL # _____

This warranty gives you specific legal rights. You may have other rights which vary from state to state.

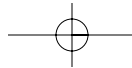

Index 47

-
- ac power cord7, 22
 - accessories.....48
 - ant(enna) in jack.....6 - 10, 22
 - audio in/out jacks.....10, 22, 33
 - auto return.....30
 - auto satellite link.....31
 - automatic
 - playback.....41
 - rewind, eject, off.....41
 - batteries.....5
 - cassette compartment20
 - ch3/ch4 switch.....7, 9, 22
 - channel
 - above 10018
 - adding.....13
 - deleting.....13
 - setup.....11, 12
 - (▲/▼) buttons.....19, 21, 41
 - clock on-screen display17
 - clock (setting).....14 - 15
 - connections.....6 - 10, 33
 - contents, table of4
 - controls
 - remote5, 18 - 19
 - vcr20 - 22
 - count on-screen display17
 - counter memory button19, 37
 - counter reset/exit button.....19, 37
 - cst. in light.....20
 - display button.....17 - 18
 - display panel20
 - duplication33
 - eject button.....19
 - erasure prevention5
 - f.fwd button.....19, 21
 - front panel21
 - glossary.....44
 - helpful hints42 - 43
 - hookups
 - for tape duplication33
 - with a cable box/dbs.....8 - 9
 - with a stereo tv.....10
 - without a cable box/dbs6 - 7
 - index search38
 - index search button19, 38
 - language selection11, 16
 - line input mode.....33, 44
 - long play44
 - lp44
 - menu button.....18
 - number buttons.....18
 - on-screen status displays.....17
 - one-touch recording25
 - out jack.....7 - 9, 22, 33
 - pause button21
 - pause/still button.....19, 24, 35
 - play button.....18, 21, 23, 35
 - playing23
 - power
 - button18, 21
 - cord7, 22
 - light20
 - quick find.....40
 - quick-find button.....18
 - rear panel.....22
 - rec(ord) light.....20
 - rec/otr button.....21
 - record button18
 - record tab5
 - recording
 - basic.....24
 - one channel/watching another ..32
 - timer26 - 29
 - remote
 - control
 - buttons18 - 19
 - using5
 - sensor.....5, 21
 - rental play36
 - repeat play34
 - rerecording.....33
 - rew(ind) button.....21
 - rewind button.....18
 - rf coaxial cable.....6 - 9, 33, 44
 - safety precautions3
 - searching
 - forward/reverse35
 - index38
 - time39
 - sensor (remote).....5, 21
 - slow
 - button18
 - motion35
 - slp.....44
 - sp.....44
 - speed button18
 - standard play44
 - status display17
 - still picture.....35
 - stop button.....19
 - stop/eject button.....21
 - super long play.....44
 - table of contents4
 - tape
 - duplication33
 - eject.....41
 - speed.....44
 - time search39
 - time search button19, 39
 - time (setting).....14 - 15
 - timer
 - light20
 - recording
 - cancelling.....29
 - correcting.....29
 - setting26 - 28
 - tracking.....41
 - tv
 - hookups6 - 10, 33
 - position.....19, 21, 32, 43
 - vcr position.....19, 21
 - vcr/tv button19, 21
 - vcr/tv light20
 - video in/out jacks.....10, 22, 33, 44
 - warranty46

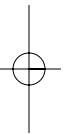
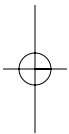

SUPPLIED ACCESSORIES

Check to be sure the items on this page are packed with your VCR. These accessories are provided to help you use or set up your VCR.

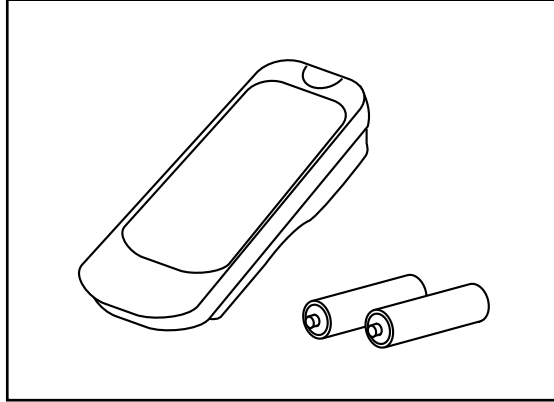

Remote Control 4835 218 37219
Two "AA" Batteries 4835 138 17012

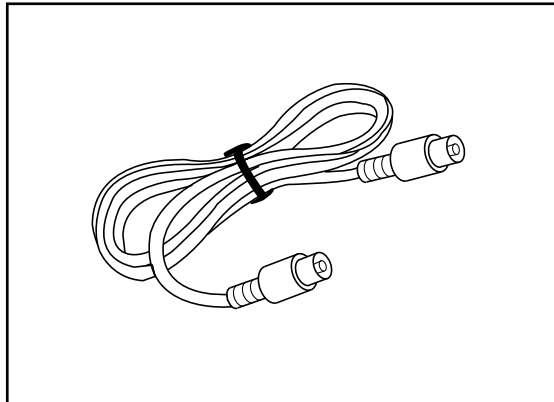

RF Coaxial Cable, 75 ohm 4835 323 27011

If any of these items are not included, or if you need to replace an item, contact our Service Solutions Group at the address below.

***Service Solutions Group
P.O. Box 967
Greenville, TN 37744-0967***

Or, call 1-800-851-8885.